



ADT761 Series Automated Pressure Calibrator

ADT761 Series Automated Pressure Calibrator

————— **User Manual**

Please download the latest version from www.additel.com

[Version: 1411V04]



Additel Corporation

STATEMENT

This technical manual provides operating and safety instructions for the ADT761 Series Automated Pressure Calibrator. To ensure correct operation and safety, please follow the instructions in this manual. Additel reserves the right to change the contents and other information contained in this manual without notice.

CONTENTS

Warnings	1
General safety	2
1. Introduction	3
1.1 Overview	3
1.2 Features	3
1.3 Specifications	4
2. Installation	5
2.1 Features	5
2.1.1 Basic structure	5
2.1.2 Electrical terminals and signal interface	6
2.1.3 RS-232 interface	6
2.1.4 Keypad	7
2.1.5 Pneumatic port	8
2.2 Initial preparation	8
2.2.1 Battery installation	8
2.2.2 Changing the belt strap	9
2.2.3 Pneumatic connection	9
2.2.4 View the display	9
2.3 Getting started	10
2.3.1 Power on.....	10
2.3.2 Setting the system date and time	10
2.3.3 Generating a pressure	10
3. Function and operation	11
3.1 Display and basic operation	11
3.1.1 Home screen	11

3.1.2 Pressure output	12
3.1.3 Pressure measure	13
3.1.4 Pressure unit	14
3.1.5 Current output	14
3.1.6 Current / voltage measure	15
3.1.7 Switch test	15
3.1.8 External pressure module	16
3.1.9 Scaling	17
3.1.10 Zero	17
3.1.11 Step	17
3.1.12 Snapshot	19
3.1.13 Vent	19
3.2 HART.....	20
3.2.1 Poll	20
3.2.2 Process variables	21
3.2.3 Setup	22
3.2.4 Service	23
3.3 Typical applications in the main screen	24
3.3.1 Calibrating pressure gauges	24
3.3.2 Calibrating pressure transmitters.....	24
3.3.3 Calibrating HART transmitters	25
3.3.4 Calibrating pressure switches	26
3.3.5 Calibrating I/P converters	27
3.3.6 Calibrating isolator / convert / signal-acquiring devices	27
3.4 Setup	28
3.4.1 Control setup	28
3.4.2 24V power	29

3.4.3 Display setup	29
3.4.4 Date and time	30
3.4.5 Language	31
3.4.6 Factory default	31
3.4.7 Tools	31
3.4.7.1 Leak test	31
3.4.7.2 Vent	33
3.4.7.3 Unit conversion	33
3.4.7.4 Help	34
3.4.8 Information	34
3.4.9 System Calibration	34
3.4.9.1 Current / voltage measure	35
3.4.9.2 Current source	35
3.4.9.3 High / low range	35
3.4.9.4 External pressure module	36
3.4.9.5 Self tune	36
3.4.10 RS232 setup	36
3.5 Task	36
3.5.1 Calibrating dial pressure gauges	37
3.5.2 Calibrating digital pressure gauges	40
3.5.3 Calibrating pressure transmitters	40
3.5.4 Calibrating HART transmitters	43
3.5.5 Calibrating pressure switches	44
3.5.6 Calibrating I/P converters	45
4.Troubleshooting.....	47
4.1 Device information	47
4.2 Prompt.....	47

4.3 Checking system for leaks	48
4.3.1 Checking for leaks	48
4.4 Instability	49
5. Special Application for Barometric Pressure	50
5.1 ADT761 Basic differences.....	50
5.2 Gas head correction	50
5.3 Specific ADT761-BP applications.....	50
5.3.1 Digital barometer	50
5.3.2 Mercurial barometer	52
5.3.3 Aneroid barometer	53
5.3.4 Barometer altimeter	54
5.3.5 Pressure transmitter	55
5.3.6 Pressure switch	55
Appendix A Data Sheet	56
A.1 Environment	56
A.2 Power	56
A.3 Technical specification	56

Warnings

- ◆ Do not combine with another pressure source where pressure is being generated by both sources at the same time. Additel's warranty will not cover this application.
- ◆ Do not apply pressures greater than the maximum working pressure. Additel's warranty will not cover this application.
- ◆ Not for use in flammable, high humidity, or dusty environments.
- ◆ Only charge with supplied battery (model 9722) and make sure the battery has not short circuited.

General safety

- ◆ Do not shake, drop or bump the calibrator while in use.
- ◆ If condensation has occurred, thoroughly dry out the 761 before startup.
- ◆ Connecting the REF/FLT port to the reference port of unit under test (UUT) with a small differential pressure range might result in control problems over time as the environmental temperature changes. Disconnect the ports and reconnect to resolve control issues.
- ◆ The vent port should not face the operator during venting.
- ◆ Do not apply excessive voltage or current to the electrical terminals.
- ◆ Do not use any adapter other than Additel model 9818. Charge as soon as the battery symbol indicates.
- ◆ If the calibrator is not working properly, turn it off, remove the battery and contact Additel.
- ◆ Do not remove the battery while it is charging or when the calibrator is in use.
- ◆ Before turning off the calibrator, make sure the system pressure is reduced to the atmosphere pressure.

1. Introduction

1.1 Overview

The ADT761 Series Automated Pressure Calibrator generates pneumatic pressure rapidly with high precision and stability. Precision measurement and digital control technology developed by Additel are used in the ADT761.

With dual pressure sensors, precision electrical measurement and source, the ADT761 calibrator provides many different ways to calibrate and test a variety of devices such as, dial pressure gauges, digital pressure gauges, pressure transmitters, pressure switches and I/P converters.

1.2 Features

- ◆ Automatically generates pressure with high precision.
- ◆ Excellent response time.
- ◆ HART communication.
- ◆ Loop power supply at 24V.
- ◆ Task management firmware which stores and archives test procedures and results.
- ◆ 800x480 TFT LCD with friendly HMI.
- ◆ Multi-lingual display.
- ◆ Rechargeable Li battery.
- ◆ Light weight and portable.
- ◆ Built-in leak test.
- ◆ Updateable firmware.

1.3 Specifications

Model	Pressure Range	Range 1	Range 2
ADT761-LLP	-25 to 25 mbar (-10 to 10 inH ₂ O)	-2.5 to 2.5 mbar (-1 to 1 inH ₂ O)	-25 to 25 mbar (-10 to 10 inH ₂ O)
ADT761-D	-0.95 to 1 bar (-13.5 to 15 psi)	-25 to 25 mbar (-10 to 10 inH ₂ O)	-0.95 to 1 bar (-13.5 to 15 psi)
ADT761-L	-0.95 to 7 bar (-13.5 to 100 psi)	-0.95 to 2.5 bar (-13.5 to 35 psi)	0 to 7 bar (0 to 100 psi)
ADT761-M	-0.90 to 25 bar (-13 to 375 psi)	-0.90 to 2.5 bar (-13 to 35 psi)	0 to 25 bar (0 to 375 psi)
ADT761-H	-0.90 to 40 bar (-13 to 600 psi)	-0.90 to 2.5 bar (-13 to 35 psi)	0 to 40 bar (0 to 600 psi)
ADT761-LA	-0.95 to 7 bar (-13.5 to 100 psi)	-0.95 to 2.5 bar (-13.5 to 35 psi)	-0.95 to 7 bar (-13.5 to 100 psi)
	0.05 to 8 bar.a (1.2 to 115 psi.a)	0.05 to 3.5 bar.a (1.2 to 50 psi.a)	0.05 to 8 bar.a (1.2 to 115 psi.a)
ADT761-MA	-0.90 to 25 bar (-13 to 375 psi)	-0.90 to 2.5 bar (-13 to 35 psi)	-0.9 to 25 bar (-13 to 375 psi)
	0.1 to 26 bar.a (1.7 to 390 psi.a)	0.1 to 3.5 bar.a (1.7 to 50 psi.a)	0.1 to 26 bar.a (1.7 to 390 psi.a)
ADT761-HA	-0.90 to 40 bar (-13 to 600 psi)	-0.90 to 2.5 bar (-13 to 35 psi)	-0.9 to 40 bar (-13 to 600 psi)
	0.1 to 41 bar.a (1.7 to 615 psi.a)	0.1 to 3.5 bar.a (1.7 to 50 psi.a)	0.1 to 41 bar.a (1.7 to 615 psi.a)
ADT761-BP	100 to 1200 hPa	100 to 1200 hPa	N/A

Additel reserves the right to change specifications and other information contained in this manual without notice.

2. Installation

2.1 Feature

2.1.1 Basic structure



Figure 2-1 Basic structure

2.1.2 Electrical terminals and signal interface

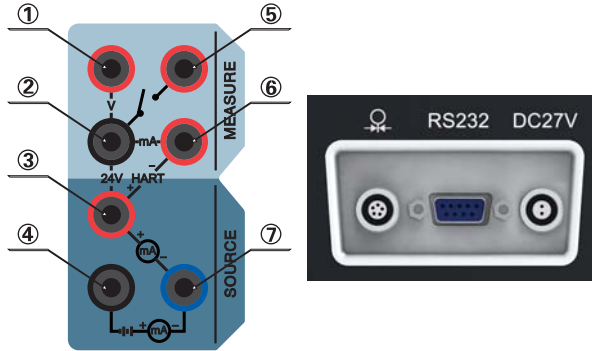

Figure 2-2 Electrical terminals and signal interface

Terminal and Interface	Introduction
6 and 2	Current measure.
1 and 2	Voltage measure.
5 and 2	Switch test.
3 and 6	HART communication.
7 and 4	Current output (external power).
3 and 7	Current output (internal power).
3 and 2	Loop power supply at 24V.
Pressure module connection	Works with ADT160 pressure modules.
RS-232 interface	Computer interface.
DC27V input	Power supply and battery recharge.

Table 2-1 Electrical terminals and signal interface

2.1.3 RS-232 interface

- ◆ The RS-232 interface is designed as a 9 pole SUB-D-socket, Pin-configuration see Figure table 2-2.

Pin	1	2	3	4	5	6	7	8	9
Configuration	N.C.	TX	RX	N.C.	GND	N.C.	N.C.	N.C.	N.C.

Table 2-2 Pin configurations

2.1.4 Keypad





Key	Introduction
	Turns the power on and off
HART	Enters HART communication mode
TASK	Enters task management mode to calibrate a device
SETUP	Enters setup mode to modify operating parameters
SAVE	Stores snapshots
VENT	Vents the calibrator
STANDBY	Disables control
Esc	Quits and returns to the previous menu
 Enter	Confirms the entry
	Moves the cursor
F1 , F2 , F3 , F4	Perform the function defined by the label above each key on the display
0 ~ 9 _{wxyz} ,  , 	Numeric keypad used whenever a numeric entry is required

Table 2-3 Key functions

2.1.5 Pneumatic port

- ◆ **OUTLET port:** The calibrator provides the controlled pressure output to the UUT. The range of the pneumatic volume for control is (0~100) cc and should not be exceeded.
- ◆ **REF/FLT port:** ADT761-BP (port is blocked). ADT761-LLP/D (port is the reference or low port. Leave open to measure in gauge mode). All other ADT761 models (port contains a filter for internal pump. The filter should be changed when dirty, as shown in figure 2-3).
- ◆ **VENT port:** The port which pressure is released from the system.

2.2 Initial preparation

2.2.1 Battery installation

As shown in Figure 2-4, install the model 9722 battery in the bottom of calibrator with a 3mm wrench.

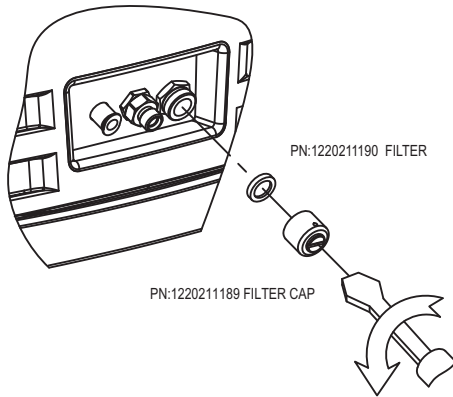

Figure 2-3 How to change filter

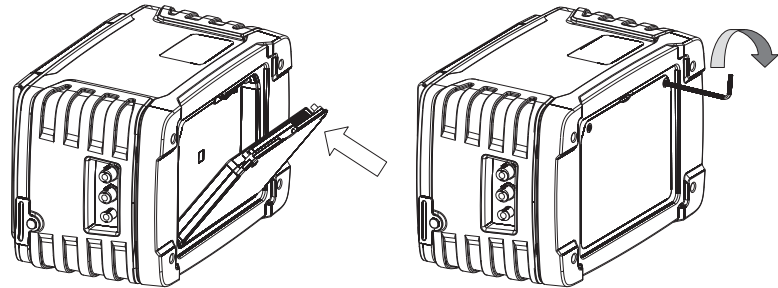

Figure 2-4 Battery installation

2.2.2 Changing the belt strap

As shown in Figure 2-5, change the belt strap with an 8 inch wrench.

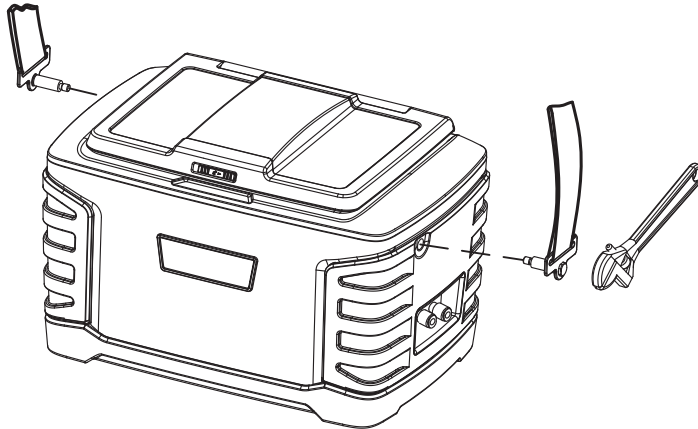

Figure 2-5 Changing the belt strap



Figure 2-6 Pneumatic connection



Figure 2-7 Pneumatic connection

2.2.3 Pneumatic connection

As shown in Figure 2-6 shows pneumatic connection of ADT761-LLP and ADT761-D. Figure 2-7 shows pneumatic connection of ADT761-L, ADT761-LA, ADT761-M, ADT761-MA, ADT761-H and ADT761-HA., connect the OUTLET and REF/FLT ports to the UUT or use plugs when necessary.

2.2.4 View the display

Push the front lock to the right and raise the screen to the proper position.

2.3 Getting started

2.3.1 Power on

- ◆ Press  to turn the power on.
- ◆ The startup screen shows the manufacturer's logo.
- ◆ After a short time the system enables the home screen and enters STANDBY mode as shown in Figure 2-8.
- ◆ Connect the power supply for charging if power is low.

2.3.2 Setting the system date and time

Refer to section 3.4.4 to set date and time.

2.3.3 Generating a pressure

Ensure the source screen is highlighted, enter an appropriate pressure value using the numeric keypad, press enter and calibrator will generate and control to the desired pressure (see section 3.1.2).

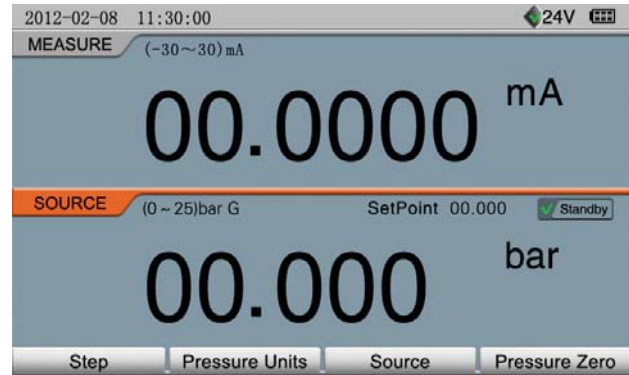

Figure 2-8 Main screen

3. Function and Operation

3.1 Display and basic operation

3.1.1 Home Screen

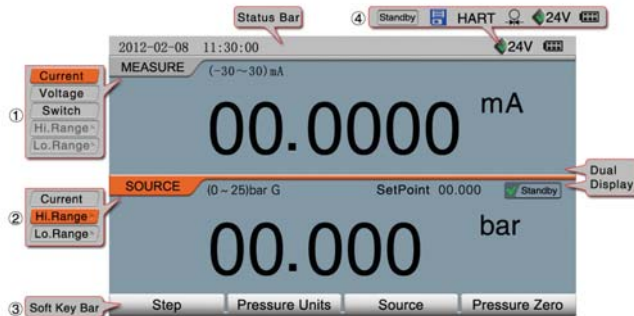

Figure 3-1 Dual display

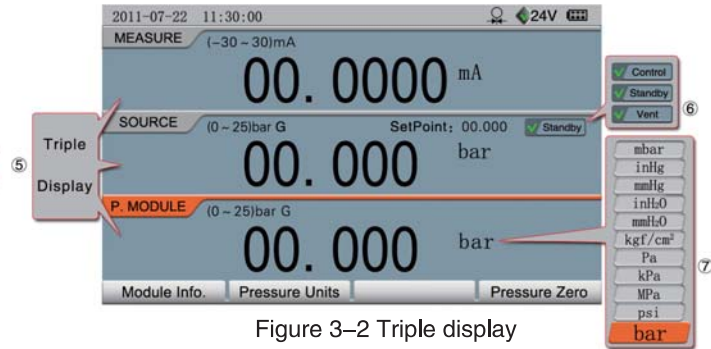

Figure 3-2 Triple display

The home screen normally contains a MEASURE window and a SOURCE window (see figure 3-1). If you select the Triple Display in the SETUP mode and connect the external pressure module, three windows will be shown (see figure 3-2). To select between the MEASURE and SOURCE window, press **▲** / **▼** till the desired window is highlighted in orange. The softkeys displayed at the bottom of the screen relate to the selected mode. Press **F3** or **↵Enter** to select what is being measured in the MEASURE window or the pressure sensor used when in the SOURCE window.

- ① Items of MEASURE: Current measure, voltage measure, switch, high pressure range, low pressure range, or pressure module.
- ② Items of Source: Current source, high pressure range, low pressure range, or pressure module.

- ③ Function keys: **F1**、**F2**、**F3**、**F4**
- ④ Status bar: Run mode (not visible in the home screen), snapshot, HART online, pressure module online, 24V power status, battery level.
- ⑤ Triple display: If the triple display is enabled, then three windows will be shown when the pressure module is connected.
- ⑥ The pressure output mode: Press **STANDBY** / **VENT** to change to standby mode, exit the control mode, or to vent the calibrator.
- ⑦ Pressure units menu: Up to 11 selectable pressure units.

3.1.2 Pressure output

1. Select High/Low Pressure Range in source mode.

- ◆ The calibrator must be vented or in standby mode.
- ◆ The calibrator will automatically vent when switching ranges.

2. Connection: Complete the pneumatic connection as shown in Figure 3-3 or Figure 3-4.

3. Entering a value

- ◆ Use the numeric keypad to enter the value, and press **F4** / **↵Enter** to confirm.
- ◆ If there is no operation within 10 seconds, the calibrator will automatically cancel the entry.
- ◆ The value must meet the control range of the calibrator.
- ◆ The maximum negative pressure is -13.5 psi (-0.95 bar). But this is dependent on the local atmospheric pressure.
- ◆ The value cannot exceed the control range of the CONTROL SETUP, or the calibrator will prompt the user to reset the limits.



Figure 3-3 Gauge pressure source



Figure 3-4 Differential pressure source

- ◆ If you've selected the low pressure sensor and enter a pressure value that exceeds the low sensor range, then the calibrator will ask if you would like it to automatically switch to the high pressure sensor.

4. Control

- ◆ Confirm the set value, and the calibrator will automatically start controlling to the set point.
- ◆ The control may be paused at any time by pressing **STANDBY**.
- ◆ The following functions are disabled in the CONTROL mode: Pressure Zero (Section 3.1.10), Step (Section 3.1.11), Leak Test (Section 3.6.1), VENT (Section 3.6.2), and Calibration (Section 3.7).

5. Stabilize

- ◆ When the calibrator reaches a stable condition as defined in the CONTROL SETUP (Section 3.4.1), the color of the displayed value will change from black to green.

3.1.3 Pressure measure

1. Select the High/Low Pressure Range in measure mode.

- ◆ The calibrator will vent as it switches ranges.
- #### 2. Connection: Complete the pneumatic connection to the external pressure source as shown in Figure 3-5.
- #### 3. External pressure source:
- ◆ Avoid applying pressure greater than the maximum working pressure to the calibrator.
 - ◆ If the value falls outside the current pressure range, the color of the displayed value will change from black to red and the calibrator will alarm.
 - ◆ If the external pressure is potentially damaging to the calibrator, it will automatically vent and an over pressurization prompt will appear.

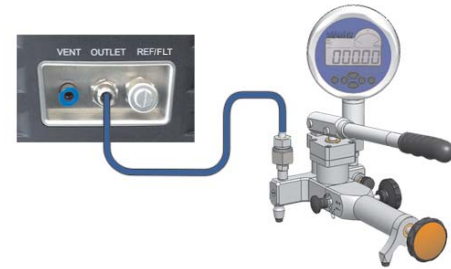

Figure 3-5 Pressure measure

3.1.4 Pressure unit

- ◆ Press **F2** to select a pressure unit in the SOURCE window, or when measuring an external pressure module in the MEASURE window.
- ◆ The selected units relate to the range and resolution of the internal sensors (Section 3.4.3).

3.1.5 Current output

1. Select Current in SOURCE mode
 - ◆ The calibrator must be vented or in standby mode to change from sourcing pressure to current.
2. Connection: Complete the electrical connection as shown in Figure 3-6 or Figure 3-7.

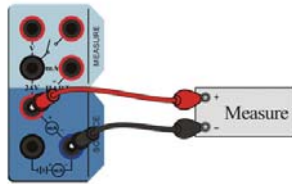

Figure 3-6 Internal 24V power supply

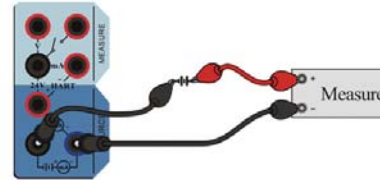

Figure 3-7 External power supply

3. Power supply

- ◆ Press **F4** to select internal loop power or external loop power.
- ◆ The default setting for the DC24V power is to remain on unless external loop power is selected

4. Entering a value

- ◆ Use the numeric keypad to enter a value, and press **F4** / **↵Enter** to confirm.
- ◆ If there is no operation within 10 seconds, the calibrator will automatically cancel the entry.
- ◆ The value must be within the range of (0~22) mA.

3.1.6 Current/voltage measure

1. Selected Current or Voltage in MEASURE mode.
 - ◆ Do NOT apply voltage / current that exceeds the current / voltage range.
 - ◆ Press **F4** to zero.
 - ◆ If the value falls outside the current/voltage range, the color of the display value will change from black to red and the calibrator will issue the alarm.
 - ◆ If the value exceeds the measure limit of the calibrator, the value will be shown as “ _ _ _ _ _ ” and the calibrator will issue the alarm.
2. Connection: complete the electrical connection as shown in Figure 3-8 or Figure 3-9.

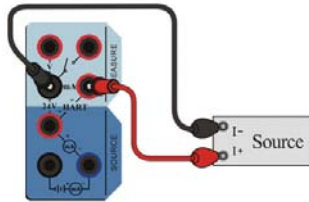

Figure 3-8 Current measure

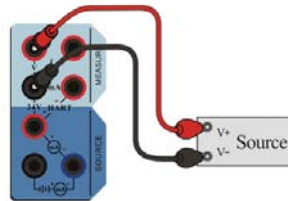

Figure 3-9 Voltage measure

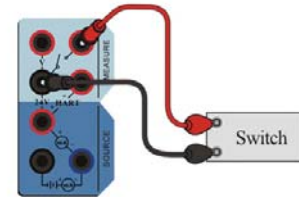

Figure 3-10 Switch test

3.1.7 Switch test

1. Select Switch in MEASURE mode.
2. Connection: Complete the electrical connection as shown in Figure 3-10.

3. Trip values

- ◆ The switch test will only work if the SOURCE window is set to source pressure.
- ◆ The calibrator records the trip values and the state (open/close) of the switch.
- ◆ Press **F2** to erase trip values.

3.1.8 External pressure module

1. Connection: complete the pressure module connection as shown in Figure 3-11.

2. Display

- ◆ A symbol will be shown on the status bar indicating an external pressure module is online. The home screen will show three windows with the TRIPLE DISPLAY when it is enabled in DISPLAY SETUP.
- ◆ Both the MEASURE and SOURCE can be changed to read the external pressure module.
- ◆ If the value falls outside the external pressure module's pressure range, the color of the displayed value will change from black to red and the calibrator will issue the alarm.
- ◆ If the value exceeds the measure limit of the external pressure module, the value will be shown as “_____” and the calibrator will issue the alarm.



Figure 3-11 External pressure module

3. Operations

- ◆ Press **F2** to select a pressure unit (Section 3.1.4 and Table 3-2).
- ◆ Press **F1** to display the information of the pressure module.

3.1.9 Scaling

- ◆ When a current or voltage is being measured, the calibrator can scale the signal to display pressure or % of full scale.
- ◆ Press **F2** to set correlative parameter.

3.1.10 Zero

- ◆ When offset occurs a Pressure Zero or Electrical Zero can be applied to the High/Low Range pressure, Current/Voltage measure, or external pressure module.
- ◆ Zero can be done within 1%FS of the pressure or 0.1%FS of the Current/Voltage.

3.1.11 Step

1.Setup

- ◆ Press **F1** to setup the step parameter in SOURCE mode.
- ◆ Starting point (V_s) and Ending point (V_e).
 - 1) They cannot be equal (if $V_s < V_e$, ascend first and $V_{min} = V_s$, $V_{max} = V_e$. If $V_s > V_e$, descend first and $V_{min} = V_e$, $V_{max} = V_s$).
 - 2) The unit is the same as the unit of Source item.
- ◆ Step Mode and size. The output values of the steps are calculated as follows:
 - 1) The step size of point number(N), and the output values(n):
$$V_{min} + (n-1) * (V_{max} - V_{min}) / (N - 1), \quad n = 1, 2, \dots, (n-1) \leq N - 1$$

2) The step of engineering unit(E), and the output values(n):

$$V_{min} + (n-1) * E, \quad n = 1, 2, \dots (n-1) * E \leq V_e$$

3) The step of scale(P), and the output values(n):

$$V_{min} + (V_{max} - V_{min}) * (n-1) * P\%, \quad n = 1, 2, \dots (n-1) * P\% \leq 1$$

note: ① The range must be divisible by the step size.

② The step range cannot exceed the range of the calibrator.

③ The step range cannot exceed the control range of the CONTROL SETUP, or the calibrator will prompt the user to reset the limits.

◆ Stroke mode: select the One Way or the Two Way.

◆ Wait Time:

1) For the auto mode only, the range is 1~3600 seconds.

2) When SOURCE is set to Current the wait time is time between mA steps.

3) When SOURCE is pressure, the wait time is the duration after the pressure has stabilized.

2. Run

◆ Press **F4** to start.

◆ Manual mode: press **F4** to advance to the next step and then press **F1** to end.

◆ Auto mode: the calibrator will run the steps automatically. Press **F4** to pause or continue, and then press **F1** to end.

3.1.12 Snapshot

1. Snapshot

- ◆ In the home screen press **SAVE** to store a record that includes a record of the date, time, source value, measure value, and 24V status. The snapshot symbol flashes on the status bar.
- ◆ The snapshot files are named numerically.
- ◆ Store up to 900 snapshots.
- ◆ The snapshot function can be used in HART mode.

2. Management

- ◆ To view the snapshot list, press and hold **SAVE** for two seconds or press **SETUP** and select the snapshot item.
- ◆ Press **◀ / ▶** to page up and down.
- ◆ Press **F2 / F3** to delete the record(s).
- ◆ The record(s) can be uploaded to a computer by the RS232 port to Additel/Land software.

3. Prefix

- ◆ Press **F4** to add a prefix to the file name.
- ◆ Allows for an alphanumeric entry or press numerical keypad to input special codes.

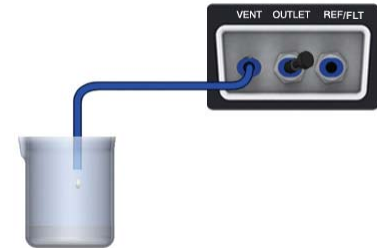

Figure 3-12 Vent

3.1.13 Vent

- ◆ The calibrator opens the vent valve to reduce pressure to atmosphere pressure.
- ◆ When venting dust or contaminants are blown out through the vent port as shown in Figure 3-12.

- ◆ Do not point the Vent port toward the operator during venting.
- ◆ **VENT** Will end the leak test.
- ◆ Press **VENT** to stop any pressure generation or control and return to barometric pressure. Press **VENT** again to close the vent valve and switch to Standby mode.
- ◆ When setting a decreasing pressure value, the calibrator will automatically vent when the pressure reaches the Vent P pressure in the Control Setup.

3.2 HART

3.2.1 Poll

1. Connect

- ◆ Use the internal series resistor and internal 24V loop power supply as shown in Figure 3-13.
- ◆ Use the internal series resistor and external loop power supply as shown in Figure 3-14.
- ◆ Use the external series resistor and external loop power supply as shown in Figure 3-15.

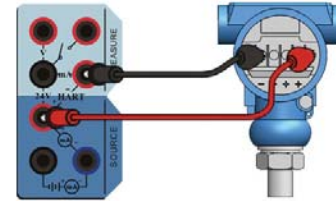

Figure 3-13 Internal series resistor and internal 24V loop power supply



Figure 3-14 Internal series resistor and external loop power supply

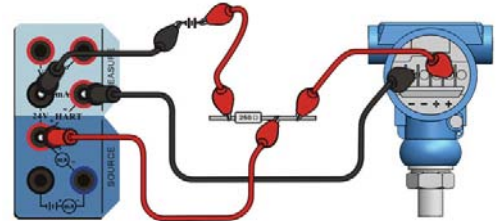

Figure 3-15 External series resistor and external loop power supply

2. Poll

- ◆ Ensure a proper connection (see connections above). From the home screen, press **HART** to start the HART function.
- ◆ The calibrator will poll address 0. If no connection is made, it will scan from address 1 to 15.
- ◆ Once the calibrator establishes communication with the transmitter, the transmitter will be added into the HART device list.
- ◆ Press **F1** / **Esc** to stop the polling.
- ◆ Press **F3** to restart polling.

3. Online/offline

- ◆ The HART functions are shown in the Measure window of the Home screen and the HART icon will display in the status bar after connection to the transmitter is established.
- ◆ Press **F1** / **Esc** to disconnect the HART instrument and the HART icon will disappear.
- ◆ If HART communication is terminated, the HART function will abort and the calibrator will prompt to poll again.
- ◆ If HART communication is terminated in use, the HART function will abort.

3.2.2 Process variables

- ◆ Display HART-PV, HART-AO, HART-%, Loop mA.
- ◆ Press **F3** / **←Enter** to select the process variable to be the main value displayed in the MEASURE window.
- ◆ Select the process variable in the MEASURE screen before running a HART transmitter calibration task.

3.2.3 Setup









1. Parameters

◆ Press **F2** to setup the following functions.

Category	Sub Category	Read Only or Read and Write	Description
MFR (Manufacturer)	N/A	Read only	Transmitter manufacturer
Model	N/A	Read only	Manufacturer model number
Device id	N/A	Read only	Manufacturer device id
Tag	N/A	Read and write	Enter an alphanumeric tag. (8 max length)
Device Info	Address	Read and write	Polling address: Interger (0~15)
	Date	Read and write	Any accepted date
	Descriptor	Read and write	Enter an alphanumeric tag. (16 max length)
	Message	Read and write	Enter an alphanumeric tag. (32 max length)
	Write Protect	Read only	Manufacturer setting
Revision	Hart Revision, No req preams,	Read only	Manufacturer revision settings
	Software rev, Hardware rev		
Sensor	PV Snsr s/r	Read only	Manufacturer setting
	PV Snsr Unit	Read only	Sensor pressure unit
	PV LSL	Read only	Process variable lower limit
	PVUSL	Read only	Process variable upper limit
	PV Min Span	Read only	Process variable span
Signal	PV Unit	Read and write	Process variable pressure unit
	PV LRV	Read and write	Process variable lower limit
	PV URV	Read and write	Process variable upper limit
	Damping	Read and write	Numeric entry (0~199) seconds
	Xfer Fcn	Read and write	Selectable (Linear or Square Root)
	AO Alarm Type	Read only	Manufacturer setting for alarm state



Table 3-3 HART setup

2. Operations



- ◆ Press  /  to view the HART parameters, and press  /  to open the setting status.
- ◆ In the setting status press  /  to select and press  /  to set.
- ◆ If the operation is canceled or fails, the value of the parameter will be reset.

3.2.4 Service

1. Loop test

- ◆ Select the predefined value or manually input a value, the range is (4~20) mA, and press  /  to test. The ADT761 will then provide a mA source to the transmitter of the selected value. It will then read back the loop in real time next to the term Loop mA.
- ◆ The Loop test is not available when the HART device is in multi-drop mode. All Field Devices must be able to operate in multi-drop with loop current signaling disabled according to the HART Protocol.



2. D/A output trim

- ◆ Through adjusting the coefficient of current output, the transmitter's PVAO is consistent with loop mA.
- ◆ Press  /  to trim the Zero (DAC Zero) and Span (DAC Gain), or press  to put the mA value measured by calibrator into the Trim Value input box. The range is (4~20) mA.
- ◆ The trim is not available when the hart device is in multi-drop mode. All Field Devices must be able to operate in multi-drop with loop current signaling disabled according to the HART Protocol.

3. Zero trim

- ◆ Reduce the measure to near zero to avoid failure.

4. Re-Range

- ◆ Support to change the PV/Range unit and pressurize mode (internal pressure source or external pressure source).
- ◆ Test the pressure transmitter and change the range to adjust the shift of the output current.
- ◆ Press  /  to change the LRV/URV, or press  to put the PV value into the New LRV/URV input box.

5. Sensor Trim

- ◆ Some transmitters do not support the sensor trim function.
- ◆ A Sensor Trim can involve one or more trim points according to different transmitters.
- ◆ Support to change the PV unit and pressurize mode (Internal pressure source or External pressure source).
- ◆ The trim points in the internal pressure source mode cannot exceed the control range of the Control Setup, or the calibrator will prompt the user to reset limits.
- ◆ Press **F4** / **↵Enter** to trim point, or press **F2** to put the pressure value sourced by calibrator into the Trim Value input box.

3.3 Typical applications in the main screen

3.3.1 Calibrating pressure gauges

1. Prepare
 - ◆ Select High range or Low range in SOURCE mode.
2. Connect
 - ◆ Complete the pneumatic connection as shown in Figure 3-16.
 - ◆ For low range differential sensors, connect the REF/FLT port to the reference port of the gauge as shown in Figure3-4.
3. Pressurize manually or by the Step function (Section 3. 1.11).
4. Record indicator reading of UUT manually after the pressure has stabilized.

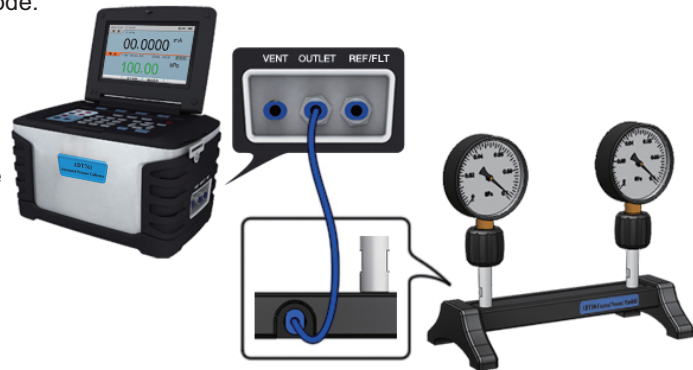

Figure 3-16 Calibrating pressure gauges

3.3.2 Calibrating pressure transmitters

1. Prepare

- ◆ Select the High or Low range in SOURCE mode.
 - ◆ Select the Current or Voltage in MEASURE mode.
 - ◆ Activate 24V power.
2. Connect
 - ◆ Complete the pneumatic connection as shown in Figure 3-17.
 - ◆ For low range differential sensors, connect the REF/FLT port to the reference port of the gauge as shown in Figure3-4.
 3. Pressurize manually or by the step function (Section 3.1.11).
 4. Record the measure value manually or by using snapshot (Section 3.1.12) after the pressure has stabilized.



Figure 3-17 Calibrating a pressure transmitter

3.3.3 Calibrating HART transmitters

1. Prepare
 - ◆ Select the High or Low range in SOURCE mode.
 - ◆ Select the current in MEASURE mode.
 - ◆ Activate 24V power.
2. Connect
 - ◆ Complete the pneumatic and the electrical connections as shown in Figure 3-13 and Figure 3-17, when using internal series resistor and 24V loop power.

3. Press **HART** to initiate communication with the HART transmitter (Section 3.2.1), and press **F3** to change the process variable to HART-AO (Section 3.2.2).
4. Press **F2** to set the parameters of the HART transmitter (Section 3.2.3).
5. Press **F4** to service the HART transmitter (Section 3.2.4).
6. Pressurize manually or by the step function (Section 3.1.11).
7. Record the measured value or by using snapshot (Section 3.1.12) after the pressure is stabilized (include 4 process variables).

3.3.4 Calibrating pressure switches

1. Prepare
 - ◆ Select the High or Low range in SOURCE mode.
 - ◆ Select the Switch in MEASURE mode.
2. Connect
 - ◆ Complete the pneumatic and electrical connection as shown in Figure 3-18.
3. Capture trip values
 - ◆ Automatic:
 - 1) Pressurize to the high limit of the UUT until the switch trips.
 - 2) Decompress to the low limit of the UUT until the switch trips.
 - 3) To capture a more precise switch point, the Slew Rate should be set to low speed in the Control Setup screen.
 - ◆ Manually:
 - 1) Pressurize to the anticipated trip point of the switch.



Figure 3-18 Calibrating a pressure switch

2) After pressure stabilizes press ◀ / ▶ increase or decrease the pressure.

4. Record the trip values manually or by using snap shot (Section 3.1.12)

3.3.5 Calibrating I/P converters

1. Prepare

- ◆ Select Current in SOURCE mode.
- ◆ Select the High or Low range in MEASURE mode.
- ◆ An external pressure module may be used to measure the process pressure.

2. Connect

- ◆ Complete the pneumatic and electrical connections as shown in Figure 3-19.
- ◆ DO NOT over pressure the calibrator.
- ◆ DO NOT use the calibrator as the pressure source.
- ◆ Check the load ability of the UUT for using the internal 24V power supply.

3. Source the current manually or by the step function (Section 3.1.11).

4. Record the measured value manually or by using snapshot (Section 3.1.12) when the pressure has stabilized.

3.3.6 Calibrating isolator/convert/signal-acquiring devices

1. Prepare

- ◆ Select the Current in SOURCE mode.
- ◆ Select the Current or Voltage in MEASURE mode.



Figure 3-19 Calibrating a I/P converter



2. Connect

- ◆ Complete the electrical connection as per the requirement of the UUT.

3. Source the current manually or by the step function (Section 3.1.11).

4. Record the measured value manually or by using snapshot (Section 3.1.12) when the measurement stabilizes.

3.4 Setup

- ◆ Press **SETUP** to enter the Setup screen which contains 12 options. Press  and **F4** /  to select.
- ◆ Any changes to the settings will become the default when the unit is powered on.

3.4.1 Control setup

1. P. Form (Pressure type)

- ◆ Two types: G-Gauge and A-Absolute. (The ADT761-LLP and ADT761-D have no control type selection)
- ◆ The symbol of the pressure type will be shown on the status bar in the home screen.

2. Ctrl LRV and Ctrl URV (Control limits)

- ◆ A range smaller than the calibrator range may be selected to limit the output pressure to avoid over pressurizing sensitive UUTs.
- ◆ The set point of the controller cannot exceed this range, or the calibrator will prompt the user to reset the limits.
- ◆ Ctrl LRV is the lower limit and Ctrl URV is the upper limit.

3. Stability Criteria

- ◆ Ctrl Stability (Control stability): the stability requirement in %FS which determines the set point stability which changes the measured value from black to green based on the delay time. The range is (0.005~10) %FS.
- ◆ Stable delay: the stability time determined after the calibrator has achieved the set point.
- ◆ The calibrator is considered stable in the following conditions.

1) (Output value-Set value) <= control stability setting.

2) Control stability is achieved within the stable delay period.

◆ Stable beep: the stable prompt sound.

4. Slew rate

◆ Pressurize at a fast/medium/slow speed.

◆ The default is fast but may be changed to better determine the precise trip value when testing a pressure switch.

5. Switch damping

◆ Averaging time period before the switch trips. The range of the time is (0.1~99) seconds and the default is 0.1.

◆ Set it according to the switch specifications, too long of a dampening time may cause an error in the trip point.

6. Auto Zero

◆ If enabled, the calibrator will automatically zero pressure value when it is in vent state and record the offset.

◆ If Absolute pressure type selected, the Auto Zero will be disabled automatically.

7. Vent P. (Vent Pressure)

◆ When the real pressure is less than the Vent Pressure setting and when controlling the zero pressure, the calibrator will automatically vent.

◆ Accepted range of Vent P.: (0~105) %FS.

3.4.2 24V power

◆ Short current protected, then the symbol indicating 24V status on the status bar will flicker.

◆ The DC24V power will stay activated when using the current Source or the HART function with internal loop power and will return to the original status after the loop power is changed.

3.4.3 Display setup

1. Resolution

- ◆ Set the resolution of data display in MEASURE mode or in SOURCE mode.
- ◆ Viewing the snapshot files, the data display according to the resolution when stored (Section 3.1.12).
- ◆ In the Task Report, the date displays according to the resolution when the task was created (Section 3.5).
- ◆ If there is a display error, it will display according to six digits.

2. Triple display

- ◆ If enabled, the home screen will show three windows when the pressure module is connected (Figure 3-2).
- ◆ If the pressure module is selected as MEASURE or SOURCE, then triple display will appear.

3. Backlight Auto Off (Turn Off Light)

- ◆ Automatically turns off the backlight after a set time.
- ◆ Accepted timeout period: Never, 5 minutes, 10 minutes, 30 minutes, 1 hour, 2 hours, and 4 hours.
- ◆ The backlight will come on by pressing any key.
- ◆ The backlight is disabled in the Step function and the Control mode.

4. Power Auto Off (Auto Power Down)

- ◆ Automatically turns off the power after a set time.
- ◆ Accepted timeout period: Never, 30 minutes, 1 hour and 2 hours.
- ◆ It is disabled in the Step function, the Control mode and the charging status.

5. Brightness

- ◆ Press **F2** / **F3** to increase or decrease the brightness.
- ◆ Accepted eleven levels.

3.4.4 Date and time

- ◆ The date and time are shown on the status bar according to the configuration.
- ◆ The date can be set from 2000-01-01 to 2099-12-31, and the range of time is from 00:00:00 to 23:59:59.
- ◆ The setting also takes into account the number of days in the month, and leap year.

3.4.5 Language

- ◆ Standard: English, Spanish, Simplified Chinese, German, French, Italian, Portuguese.
- ◆ Optional: Traditional Chinese, Japanese or Russian available upon request.

3.4.6 Factory default

- ◆ Restore instrument settings to factory default including the Control Setup, the Display Setup and the RS232 Setup. It also deletes all the snapshots and task files.
- ◆ The password is 811.
- ◆ Please note that all new settings will be erased.

3.4.7 Tools

3.4.7.1 Leak test

1. Range Selection

- ◆ Hi. Range/Lo. Range: Select the internal high/low range for pressurizing to the leak test point automatically with the calibrator.
- ◆ P. Module: pressurize with an external pressure source and measure the real pressure with an external pressure module.

2. Setup

- ◆ Select the leak test under the tools icon in the setup screen.
- ◆ Leak test with the internal ranges or the external pressure module.
 - 1) The set point and the wait time do not have to be set with the external pressure module.
 - 2) The pressure unit can be selected. The default unit is kPa. (Section 3.1.4).
- ◆ The pressure unit will return to the previous selected unit for pressurization (Section 3.1.4).
- ◆ Set point
 - 1) Do not exceed the range of the UUT.
 - 2) With the numerical key pad enter the leak test point.

- ◆ Wait time: Stabilization time at the set point. After this countdown is finished the test will begin.
- ◆ Test time: After the wait time is finished, the calibrator will stop control and be in standby mode. During the test time the calibrator will monitor the drop from the start pressure (Start P.) to the ending pressure (End P.) and the change in pressure or leakage is determined.

3. Run

◆ Internal high/low range

- 1) Press **F4** / **↵Enter** to start to pressurize to the set point and wait for the displayed pressure to stabilize.
- 2) The 761 will continue to control and the wait time will count down.
- 3) When the wait time reaches zero, the calibrator changes to the Standby mode and records the displayed pressure as the start pressure.
- 4) The test time will count down, Real leakage = Start pressure - Real pressure.
- 5) When the test time reaches zero, the calibrator records the displayed pressure as the end pressure, and then reduce the system pressure to near the atmospheric pressure.
- 6) Finally Leakage = Start pressure - End pressure.
- 7) By pressing the **STANDBY** / **F4** to pause or continue during step 1), 2), 3), 4), the run mode will be changed between the Standby and Control in step 1), 2).

◆ External pressure source

- 1) Connect to an external pressure module.
- 2) Pressurize to the leak test point with an external pressure source.
- 3) Press **F4** / **↵Enter** to start to run and record the displayed pressure as the start pressure.
- 4) Start test and the test time will count down, Real Leakage = Start pressure - real pressure.
- 5) When the test time reaches zero, record the displayed pressure as the end pressure.
- 6) Final leakage = Start pressure - End pressure.

7) Press **F4** to pause and continue during step 4).

- ◆ A graph is shown depicting each step of the test.
- ◆ Press **VENT** to vent and end the test.
- ◆ The set point with the internal ranges cannot exceed the control range of the Control Setup, or the calibrator will prompt the user to reset the limits.

3.4.7.2 Vent

This operation will clean out impurities from the calibrator by pressurizing the calibrator and venting the system.

1. Connect

- ◆ Plug the Outlet port with the provided plug.
- ◆ Please gather and properly dispose of any pollutants during venting as shown in Figure 3.20.
- ◆ The vent port should not face the operator.

2. Run

- ◆ Select vent under the tools icon in the setup screen.
- ◆ The 761 will automatically switch to the high range.
- ◆ Press **F4** / **←Enter** to pressurize to the venting pressure (Set Point).
- ◆ When the pressure reaches the venting pressure, the vent valve will open to release the system gas and other pollutants.
- ◆ Venting can be performed repeatedly.
- ◆ The set point cannot exceed the control range of the Control Setup, or the calibrator will prompt the user to reset the limits.

3.4.7.3 Unit conversion

- ◆ Select converter under the tools icon in the setup screen.
- ◆ Eleven pressure units are shown in the conversion chart.

- ◆ Entering any value with the numeric key pad will show the corresponding values in all units.

3.4.7.4 Help

The calibrator provides images and diagrams showing basic connections and typical applications.

- ◆ Select the Help in the setup screen.
- ◆ Press  /  to view.

3.4.8 Information

- ◆ Sys Info: Model, serial number, software rev, hardware rev, and manufacturing date.
- ◆ Atmos.: Provides the atmospheric pressure.
- ◆ Hi and low Range: Model, range, overload, manufacturing date, serial number, form (pressure type), accuracy, and software rev.
- ◆ P. Module: If an external pressure module is connected, the model, range, overload, and manufacturing date information is displayed.

3.4.9 System Calibration

- ◆ To ensure optimum instrument operation, the current/voltage measure, the current source and the internal dual pressure range should be calibrated at regular intervals.
- ◆ The calibrator also provides a way to calibrate the external ADT160 pressure module.
- ◆ The calibrator can also calibrate inlet pressure and atmosphere pressure.
- ◆ Making errors when calibrating will affect the precision and possibly even cause abnormalities.
- ◆ The calibration data can be restored to the factory default, and the calibration date changes to “----/--/--”.
- ◆ Recommend the use of appropriately accurate primary standards when calibrating this instrument.
- ◆ Enter the system calibration in the Setup screen and select the function.
- ◆ The password is 811.

3.4.9.1 Current/voltage measure

1. Calibration points

- ◆ The default is -30mA, 0mA, 30mA for current measure and -30V, 0V, 30V for voltage measure.
- ◆ Calibration points can be edited with the respective range as follows if needed:
 - 1) (-30~-18)mA or (-30~-18)V for negative full scale.
 - 2) (-12~12)mA or (-12~12)V for zero.
 - 3) (18~30)mA or (18~30)V for positive full scale.

2. Run

- ◆ Press **F4** / **↵Enter** to start.
- ◆ According to the calibration point prompt by the calibrator, use a more precise, higher-standardized unit generates signal to the calibrator.
- ◆ When the measured value is stable, Press **F4** / **↵Enter** to record and continue, press **F1** / **Esc** to review.

3.4.9.2 Current source

1. Calibration points

- ◆ The default is 4mA, 20mA that cannot be edited.

2. Run

- ◆ Press **F4** / **↵Enter** to start.
- ◆ The calibrator will provide the current to a standard ampere-meter on schedule. When the reading is stable, input the reading into the calibrator.
- ◆ Press **F4** / **↵Enter** to record and continue and press **F1** / **Esc** to review.
- ◆ The accepted range of the standard gauge is (0 ~ 30)mA.

3.4.9.3 High/low range

1. Calibration points

- ◆ If the range is mixed, execute in three-point mode calibration with the low limit, the zero and the high limit as default.

2) Use a standard pressure source to pressurize the calibrator and wait for the measure value to stabilize.

3) Press **F4** / **↵Enter** to record and continue and press **F1** / **Esc** to review.

◆ Once user calibration is completed, the system date will be recorded by the date of calibration.

3.4.9.4 External pressure module

1. Calibration points (as shown in Section 3.7.3-1).

2. Run

◆ Connect the external pressure module.

◆ Press **F4** / **↵Enter** to start.

◆ Use a standard pressure source to pressurize the pressure module and wait for the measured value to stabilize.

◆ Press **F4** / **↵Enter** to record and continue, and press **F1** / **Esc** to review.

3.4.9.5 Self tune

For factory test only.

3.4.10 RS232 setup

◆ Select the RS232 setup in the setup screen.

◆ Set the baudrate, databits and stopbits.

◆ Press numeric keypad to set the address, and the range is 001~121.

3.5 Task

The calibrator provides the task function for automated calibration while storing and archiving the calibration data. To use this function, press **TASK** and it provides five kinds of calibration task for the following UUTs: dial pressure gauge, digital pressure gauge, pressure transmitter, pressure switch and I/P converter. When using different types of equipment the MEASURE and SOURCE will be set automatically. The maximum number of tasks stored is 200.

◆ When the cursor is on New Task, press **F2** to delete all the tasks and data. Carefully select your operation as they cannot be reversed.

- ◆ When the cursor is on New Task, press **F4** / **↵Enter** to create a new task with the last one as a template.
- ◆ Press **▲** / **▼** to select a task and view its information, and press **◀** / **▶** to page up and down.
- ◆ Press **F2** to save as a new task.
- ◆ Press **F3** to delete the selected task and its data. Carefully select your operation as it cannot be reversed.
- ◆ If the selected task calibration has not been ran, press **F4** / **↵Enter** to show the run information screen.
- ◆ If the selected task has been ran, press **F4** / **↵Enter** to view the report.
- ◆ The task can be repeated, but only the last result will be recorded. Carefully select your operation as they cannot be reversed.
- ◆ View the run information and report. The failures are red and “-----”stands for no record.
- ◆ The data can be uploaded to a computer with RS232 interface cable. And tasks can be generated and managed on a PC using Additel/Cal software and loaded to the calibrator through the RS232 interface.

3.5.1 Calibrating dial pressure gauges

1. Connect
 - ◆ Connect the calibrator to the dial pressure gauge as shown in Figure 3-20.
 - ◆ Connect the REF/FLT port to the low pressure port of the differential pressure gauge.
2. New Task



Figure 3-20 Calibrating a dial pressure gauge

- ◆ Task name
 - 1) Enter an alphanumeric name, and press numerical keypad to input special codes.
 - 2) The name cannot be the same as an existing task.
 - 3) The characters of the task name cannot exceed 13 spaces.
- ◆ Range of UUT
 - 1) Cannot exceed the output range of the calibrator.
 - 2) The high and low limit cannot be equal.
 - 3) The calibrator will automatically select the range for higher precision.
 - 4) The calibrator will use dual range if needed.
 - 5) Over pressuring can result in damage to the UUT.
- ◆ Pressure type: gauge, absolute or differential.
- ◆ Accuracy
 - 1) Preselected accuracies are available.
 - 2) Custom X.XX*: When the custom range is selected, press F2, and the field can be edited to the desired accuracy from (0.01 to 100)%FS.
- ◆ Calibration points
 - 1) The range is 2 to 17.
 - 2) Scale will default to linear steps over the chosen range of the UUT.
 - 3) Each test point can be edited individually.
 - 4) Setting a point to less than -0.95bar will be adjusted to -0.95bar.
- ◆ Resolution
 - 1) To format the indicator of the UUT.

2) When the Scale input form is selected, Real Indicator = Experted + Offset * Resolution.

3) Resolution entered in terms of the unit resolution (e.g. resolution of 0.1 when measuring in bar is 0.1 bar).

- ◆ Tapping: Tap or no tap during the calibration process of the analog gauge.
- ◆ Cycles: 1 to 3.

3. Run

- ◆ Input the information before running including the date (the default is the system date), the ambient temperature, (the default is 25°C and the range is 0~25°C) and the relative humidity (the default is 40%RH and the range is 0~100%RH).
- ◆ Pressure Source: Select the Internal Pressure or Pressure Module.
- ◆ Start and wait for the displayed pressure to stabilize. Input the reading of the UUT that cannot exceed 110% full-scale of the UUT. When continuing with no input, the standard value will be recorded as the indicator. If tapping is enabled, the calibrator will ask you to input the reading after tapping the indicator. Complete this step and continue.
- ◆ Continue through the remaining pressure set points until finished. You can then generate a calibration report.
- ◆ When dual range is being used, the calibrator will switch the pressure range automatically.
- ◆ The calibration points of the task cannot exceed the control range of the Control setup, or the calibrator will prompt the user to reset the limits.
- ◆ The calibrator will automatically switch to the suitable range if needed.

3.5.2 Calibrating digital pressure gauges

1. Connect

- ◆ Connect the calibrator to the digital pressure gauge as shown in Figure 3-21.
- ◆ When testing a differential pressure gauge use the REF/FLT port to connect to the low pressure port of the differential pressure gauge.

2. New and run

The task set up and run is very similar to a dial pressure gauge (Section 3.5.1) except:

- ◆ Accuracy settings where the accuracy can be defined as a % of FS or a % of reading or a combination of %FS and % of reading.



Figure 3-21 Calibrating a digital pressure gauge

3.5.3 Calibrating pressure transmitters

When calibrating a pressure transmitter, the calibrator will measure and record the current/voltage from the transmitter, supply 24V loop power, at every desired set point automating the full calibration.

1. Connect

- ◆ Connect the calibrator to the pressure transmitter as shown in Figure 3-22.

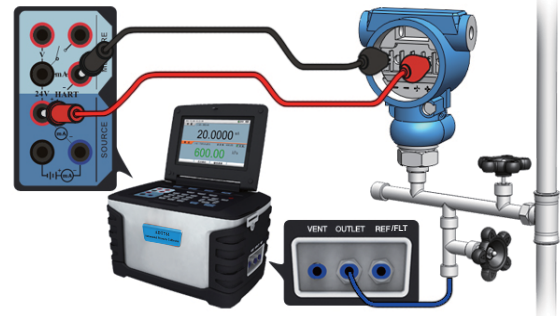

Figure 3-22 Calibrating a two-wire pressure transmitter

- ◆ When testing a differential pressure transmitter use the REF/FLT port to connect to the low pressure port of the differential pressure transmitter.

2. New

- ◆ Task name

- 1) Enter an alphanumeric name, and press to input special codes.
- 2) The name cannot be the same as an existing task.
- 3) The characters of the input test name cannot exceed 12 spaces.

- ◆ Range of UUT

- 1) Cannot exceed the range of the calibrator.
- 2) The high and low limit cannot be equal.
- 3) The calibrator will automatically select the range for higher precision.
- 4) The calibrator will use the dual range if needed.
- 5) Over pressuring the UUT may result in damage to the UUT.

- ◆ Pressure type: Gauge, Absolute or Differential.

- ◆ Accuracy

- 1) Preselected accuracies are available
- 2) Custom X.XX*: When the custom range is selected, press F2, and the field can be edited to the desired accuracy from (0.01 to 100)%FS.

- ◆ Calibration points

- 1) The range is 2~17.
- 2) Scale will default to linear steps over the chosen range of the UUT.
- 3) Each test point can be edited individually.
- 4) The points less than -0.95bar will be adjusted to -0.95bar.

- ◆ Measure signal
 - 1) Includes six selections of typical pressure transmitters.
 - 2) Calibrate a HART transmitter as seen in Section 3.5.4.
 - 3) Custom mA *(X-XX)mA: the range is (-30~30) mA.
 - ◆ Transfer function
 - 1) Linear: the output and measure are both linear.
 - 2) Square root: The output is linear, but the measure value is square root.
 - ◆ Cycles: 1~3.
3. Run
- ◆ Input the information before running including the date (the default is the system date), the ambient temperature (the default is 25 °C and the range is 0~50 °C) and the relative humidity (the default is 40%RH and the range is 0~100%RH).
 - ◆ Pressure Source: Internal Pressure or Pressure Module.
 - ◆ Select the run mode
 - 1) Automatic: When the pressure is stable, the calibrator will count down based on the Reading Time in seconds before taking the measurement and continuing to the next set point.
 - 2) Manual: press **F4** / **←Enter** to continue after the pressure has stabilized.
 - ◆ Start and wait for the displayed pressure to stabilize, and then record the measured value. Complete this step and continue.
 - ◆ The set points are generated automatically and after the test is complete a report is generated automatically.
 - ◆ When dual range is used, the calibrator will switch the pressure range automatically.
 - ◆ The calibration task used cannot exceed the control range of the Control Setup, or the calibrator will prompt the user to reset the limits.

- ◆ The calibrator will automatically switch to the suitable range if needed.

3.5.4 Calibrating HART transmitters

1. Connect

- ◆ Connect the calibrator to the HART transmitter as shown in Figure 3-13 and Figure 3-22 in the internal series resistor and internal 24V loop power mode.

2. New

- ◆ Measure signal:

- 1) HART.
- 2) Process variable: HART-PV, HART-AO, HART-%, Loop mA.

- ◆ Transfer function.

- 1) Linear: the output and measure are both linear.
- 2) Square root: when the process variable is AO or loop mA, the output is linear, but the measure is square root.

- ◆ The other introduction is similar with calibrating a common pressure transmitter (Section 3.5.3).

3. Run

- ◆ Poll HART devices automatically if needed or press **F2** to do it manually (Section 3.2.1).
- ◆ Compare the range of the task settings with the real range of the HART transmitter.
- ◆ If the process variable is HART-AO, HART-% or Loop mA, the transfer function of the HART transmitter will be changed to the same as the transfer function of the task settings.
- ◆ HART disconnection will cause the task to end.
- ◆ The other introduction is similar with calibrating a common pressure transmitter (Section 3.5.3).

4. Service

- ◆ As found data is the task result showing the condition of a HART transmitter before it is calibrated.
- ◆ Press **F2** to trim the HART transmitter (Section 3.2.4).
- ◆ Press **F3** to restart the task after servicing, and the result is recorded as left.

3.5.5 Calibrating pressure switches

1. Connect

- ◆ Connect the calibrator to pressure switch as shown in Figure 3-23.

2. New

- ◆ Task name

- 1) Enter an alphanumeric name, and press numerical keypad to input special codes.
- 2) The name cannot be the same as the existing task.
- 3) The characters of the input test name cannot exceed 13 spaces.

- ◆ Pressure type: Gauge, Absolute or Differential.

- ◆ Range: Pressure range of the switch.

- ◆ Dead band range: is the minimum and maximum of the dead band, Dead band is the pressure difference between the change-of-states (i.e. OPEN-CLOSE or CLOSE-OPEN).

- ◆ Set point: The pressure which the switch will change state.

- ◆ Tolerance: The allowable variation from the set point pressure.

- ◆ Trip type: High or Low. This is the direction to which the change-of-state should happen. If the trip type is low, this means the change-of-state happens when the pressure is falling. If the trip type is high, this means the change-of-state happens when the pressure is rising.

- ◆ Cycles: 1~3.

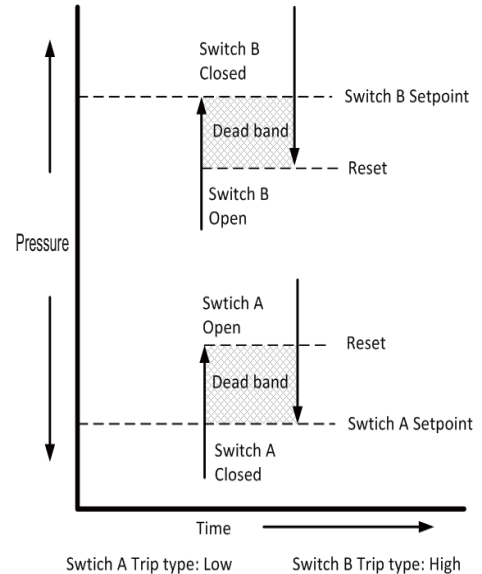

Figure 3-23 Switch Terminology

3. Run

- ◆ Input the information before running including the date (the default is the system date), the ambient temperature (the default is 25 °C and the range is 0~50 °C) and the relative humidity (the default is 40%RH and the range is 0~100%RH).
- ◆ Pressure Source: Internal Pressure or Pressure Module.
- ◆ Automatically run the task according to setting.
- ◆ Record and display the trip values in the table.
- ◆ Press **F4** / **STANDBY** to pause and continue the task and the mode will be changed between Standby and Control.
- ◆ The calibrator will automatically switch to the suitable range if needed.
- ◆ The calibrator can change the slew rate of the pressure control automatically according to the Setpoint and Tolerance of the setting, also you can change the slew rate manually by press **◀** / **▶** .

3.5.6 Calibrating I/P converters

1. Connect

- ◆ Connect the calibrator to the I/P converter as shown in Figure 3-24.
- ◆ Do not over pressure the calibrator.
- ◆ Check the load ability of the UUT for the internal 24V power supply.

2. New

- ◆ Task name.
 - 1) Enter an alphanumeric name, and press **↵** to input the special codes.



Figure 3-24 Calibrating an I/P converter

- 2) The name cannot be the same as the existing task.
- 3) The characters of the input test name cannot exceed 13 spaces.

- ◆ Output signal: According to the current range of the UUT.

- ◆ Accuracy.

- 1) Given: 0.05%, 0.1%, 0.15%, 0.25%, 0.5%, 1.0%, 1.6%.
- 2) Custom *X.XX%: When the custom range is selected, press F2, and the field can be edited to the desired accuracy from (0.01 to 100)%FS.

- ◆ Calibration points.

- 1) The range is 2~17.
- 2) Scale will default to linear steps over the chosen range of the UUT.
- 3) Each test point can be edited individually.

- ◆ Range of UUT.

- 1) Cannot exceed the measure the range of the calibrator.
- 2) The high and low limit cannot be equal.

- ◆ Cycles: 1~3.

3. Run

- ◆ Input the information before running including the date (the default is the system date), the ambient temperature (the default is 25℃ and the range is 0~50℃) and the relative humidity (the default is 40%RH and the range is 0~100%RH).

- ◆ Pressure Source: Internal Pressure or Pressure Module.

- ◆ Select the run mode.

- 1) Automatic: Set the wait time and delay time, and their ranges are both 0~3600. When the pressure is stable, the wait time will count down to zero, then the task will continue to the next set point. When the run direction is ready

to descend, the delay time will count down to zero, then the task turns to the descending points.

2) Manual: Press **F4** / **↵Enter** to continue after the pressure is stabilized.

- ◆ Start and wait for the displayed pressure to stabilize, and then record the measured value. Complete this step and continue.
- ◆ Source the current of the set points until the end and generate a report automatically.
- ◆ Recall the previous steps: press **F4** / **STANDBY** to pause and the calibrator will switch to the Standby mode, and then press **F4** / **STANDBY** to recalibrate this set point.

4. Troubleshooting

4.1 Device information

- ◆ Select the device information in the setup screen.
- ◆ View the software revision, factory date, serial number and so on.
- ◆ View the information of the high / low range inside.
- ◆ View the current atmospheric pressure.

4.2 Prompt

The display shows a screen prompt warning as follows:

Error message	Description
The calibration will be automatically matched to gauge pressure to match the internal sensor type.	As the pressure type of internal pressure sensor is gauge, the calibration should be matched with gauge pressure.
Unable to control. Please check the system for leaks.	Under the condition of system leakage, the self-tuning function will lead next steps to errors. So, the users must check if the plugs is well connected and try again.

Error message	Description
The set pressure value exceeds the maximum pressure of this device due to your atmospheric pressure.	Under the current atmosphere, the set pressure's value is higher than rated maximum pressure of device. The users should check the local atmosphere factor.
Over protection pressure range exceeded. System is venting.	While the actual output pressure is out range of RATED overpressure protecting value, the system will automatically run the vent function for self-protection.
Connecting internal pressure sensor	The system is failing to connect with internal pressure module, but it is trying over and over again.
The internal valve temperature is abnormal.	The internal valve's temperature is abnormal or irregular.
The test sensor for inlet pressure is not calibrated!	Before ADT761 generates any set pressure, all inlet air pressure will be roughly tested by a specialized pressure sensor on entrance. THIS sensor should be standardized or calibrated in factory.
Self-tuning discontinued due to the internal valve temperature.	The internal valve's temperature is abnormal or irregular, that will results the self-tuning function in errors.
Unable to find the pressure module. Please check the connection.	The system is failed to communicate with the corresponding pressure module.

Table 4-1 Prompt and disposal

4.3 Checking system for leaks

4.3.1 Checking for leaks

The calibrator must be leak free in order to function properly. Leakage may lead to control errors. A rapid pressure drop will indicate a leak in the system. Check potential problems as follows:

- ◆ Plug the OUTLET port.
- ◆ Generate a pressure, let it stabilize, and turn to standby mode. Wait for 2 minutes.

- ◆ The leak rate should be less than 0.02mbar/s for ADT761-D and 0.2bar/s for ADT761-L and ADT761-M or it is possible the calibrator has a leak.
- ◆ The ADT761 can also run an automatic leak test (as shown in Section 3.6.1).

Model	Pressure Module 1		Pressure Module 2	
	Range	Critical leak rate (mbar/s)	Range	Critical leak rate (mbar/s)
ADT761-LLP	-2.5 to 2.5 mbar (-1 to 1 inH ₂ O)	0.01	-25 to 25 mbar (-10 to 10 inH ₂ O)	0.01
ADT761-D	-25 to 25 mbar (-10 to 10 inH ₂ O)	0.01	-0.95 to 1 bar (-13.5 to 15 psi)	0.2
ADT761-L	-0.95 to 2.5 bar (-13.5 to 35 psi)	0.2	0 to 7 bar (0 to 100 psi)	0.2
ADT761-M	-0.95 to 2.5 bar (-13.5 to 35 psi)	0.2	0 to 25 bar (0 to 375 psi)	2
ADT761-H	-0.95 to 2.5 bar (-13.5 to 35 psi)	0.2	0 to 40 bar (0 to 600 psi)	2
ADT761-LA	0.05 to 3.5 bar.a (1.2 to 50 psi.a)	0.2	0.05 to 8 bar.a (1.2 to 115 psi.a)	0.2
ADT761-MA	0.1 to 3.5 bar.a (1.7 to 50 psi.a)	0.2	0.1 to 26 bar.a (1.7 to 390 psi.a)	2
ADT761-HA	0.1 to 3.5 bar.a (1.7 to 50 psi.a)	0.2	0.1 to 41 bar.a (1.7 to 615 psi.a)	2
ADT761-BP	100 to 1200 hPa	0.2	N/A	N/A

Table 4-2 The criteria leak rate of the calibrator has a leak

4.4 Instability

If the pressure has been unstable for more than 3 minutes in the CONTROL mode, the calibrator will switch to the STANDBY mode and check for the following:

- ◆ Make sure all fittings are tightened (Section 3.4.1).
- ◆ Investigate the system for any potential leaks.

5 Special Application for Barometric Pressure

The ADT761-BP is a unique calibrator and different from all the other ADT761 series calibrators.

5.1 ADT761 Basic differences

- ◆ Single range: 10kPa ~120kPa, absolute sensor type.
- ◆ Home screen: Does not support the triple display and press **F1** to switch to display mode between single window and two windows.
- ◆ Zero: This function is not available.

5.2 Gas head correction

- ◆ If enabled, the calibrator will display the correct result automatically according to the setting of parameters.
- ◆ Set the Height value in accordance with the Metric or English Units.
- ◆ Set the Density value in accordance with the Medium (i.e. Nitrogen, Dry Air, etc)
- ◆ Select standard gravity 980.665 cm/s or the local gravity based on the calibration location.

5.3 Specific ADT761-BP applications

5.3.1 Digital barometer

1. Connect

- ◆ Connect the calibrator to the digital barometer as shown in Figure 5-1.

2. New

- ◆ Task name:

- 1) Enter an alphanumeric name, and press  to input special codes.



Figure 5-1 Calibrating a digital barometer

- 2) The name cannot be the same as the existing task.
- 3) The characters of the input task name cannot exceed 12 spaces.

◆ Range of UUT:

- 1) Range: 0.1bar~1.2bar.
- 2) Cannot exceed the output range of the calibrator.
- 3) The high and low limit cannot be equal.
- 4) Over pressurizing will result in damage to the UUT.

◆ Calibration points:

- 1) The range is 2-17.
- 2) Scale the steps in accordance with the linear the UUT for the default.
- 3) Every point can be edited.

◆ Tolerance:

- 1) Given: $\pm(0.1, 0.2, 0.3, 0.4, 0.5, 1, 2, 5)$ mbar.
- 2) Custom: the custom range is (0-110)mbar.

◆ Resolution.

Given: 1, 0.1, 0.01, 0.001.

◆ Cycles: 1~3, and the default is 2.

3. Run

- ◆ Input the information before running including the date (the default is the system date), the ambient temperature (the default is 25°C and the range is 0~50°C) and the relative humidity (the default is 40%RH and the range is 0~100%RH).

- ◆ Stroke mode: One Way or Two Way.
- ◆ Wait for the displayed pressure to stabilize. Input the value from the UUT. After inputting the value for the UUT, the standard value will be recorded from the calibrator.
- ◆ After completing all the set points a report is automatically generated.

5.3.2 Mercury barometer

1. Connect

- ◆ Connect the calibrator to the mercury barometer as shown in Figure 5-2.
- ◆ Connect the REF/FLT port to the low pressure port of the differential pressure gauge.

2. New

- ◆ Task name:
 - 1) Enter an alphanumeric name, and press  to input special codes.
 - 2) The name cannot be the same as the existing task.
 - 3) The characters of the input task name cannot exceed 12 spaces.
- ◆ Range of UUT:
 - 1) Range: 0.1bar~1.2bar.
 - 2) Cannot exceed the output range of the calibrator.
 - 3) The high and low limit cannot be equal.
 - 4) Over pressuring will result in damage to the UUT.
- ◆ Calibration points:
 - 1) The range is 2-17.



Figure 5-2 Calibrating a mercurial barometer

- 2) Scale the steps in accordance with the linear the UUT for the default.
- 3) Every point value and tolerance can be edited.

- ◆ Resolution.
Given: 1, 0.1, 0.01, 0.001.
- ◆ Cycles: 1~3.
- ◆ Temperature coefficient: used to correct the value where applicable.

3. Run

- ◆ Input the information before running including the date (the default is the system date), the ambient temperature (the default is 25°C and the range is 0~50°C) and the relative humidity (the default is 40%RH and the range is 0~100%RH).
- ◆ Stroke mode: One Way or Two Way.
- ◆ Wait for the displayed pressure to stabilize.
- ◆ Input the value from the UUT. After inputting the value for the UUT, the standard value will be recorded from the calibrator.
- ◆ After completing all the set points a report is automatically generated.

5.3.3 Aneroid barometer

1. Connect

- ◆ Connect the calibrator to the aneroid barometer as shown in Figure 5-3.

2. New and Run

Creating and running the task are similar with calibrating a mercurial barometer (Section 5.3.2).



Figure 5-3 Calibrating an aneroid barometer

5.3.4 Barometer altimeter

1. Connect

- ◆ Connect the calibrator to the barometer altimeter as shown in Figure 5-4.

2. New

- ◆ Task name:

- 1) Enter an alphanumeric name, and press  to input special codes.
- 2) The name cannot be the same as the existing task.
- 3) The characters of the input task name cannot exceed 12 spaces.

- ◆ Range of UUT:

- 1) Range: 0.1bar~1.2bar.
- 2) Cannot exceed the output range of the calibrator.
- 3) The high and low limit cannot be equal.
- 4) Over pressuring will result in damage to the UUT.

- ◆ Calibration points:

- 1) The range is 2-17.
- 2) Scale the steps in accordance with the UUT.
- 3) Every point value and tolerance can be edited.



Figure 5-4 Calibrating a barometer altimeter

- ◆ Resolution: the value is 1, 0.1, 0.01, 0.001, and the default is 0.1.
- ◆ Cycles: 1~3.

3. Run

- ◆ Input the information before running including the date (the default is the system date), the ambient temperature (the default is 25°C and the range is 0~50°C) and the relative humidity (the default is 40%RH and the range is 0~100%RH).
- ◆ Stroke mode: One Way or Round Trip.
- ◆ Wait for the displayed pressure to stabilize.
- ◆ Input the value from the UUT. After inputting the value for the UUT, the standard value will be recorded from the calibrator.
- ◆ After completing all the set points a report is automatically generated.

5.3.5 Pressure transmitter

As shown in section 3.5.3 and section 3.5.4.

5.3.6 Pressure switch

As shown in section 3.5.5.

Appendix A Data Sheet

A.1 Environment

- ◆ Operating temperature: (0~50)°C.
- ◆ Storage temperature: (-20~60)°C.
- ◆ Humidity: < 90%RH, non-condensing.
- ◆ Atmospheric pressure: (0.86~1.06) bar.

A.2 Power

- ◆ Power: internal rechargeable battery or adapter.
- ◆ Charging time: less than 3 hours.
- ◆ Battery operation: typical 8 hours depending on the pressurizing frequency.

A.3 Technical specifications

- ◆ Internal pressure ranges and accuracy.

Type	Model	Pressure Range	Pressure Module 1		Pressure Module 2	
			Range	Accuracy	Range	Accuracy
Low/Differential Pressure	ADT761-LLP	-25 to 25 mbar (-10 to 10 inH ₂ O)	-2.5 to 2.5 mbar (-1 to 1 inH ₂ O)	0.05%FS	-25 to 25 mbar (-10 to 10 inH ₂ O)	0.05%FS
	ADT761-D	-0.95 to 1 bar (-13.5 to 15 psi)	-25 to 25 mbar (-10 to 10 inH ₂ O)	0.05%FS	-0.95 to 1 bar (-13.5 to 15 psi)	0.02%FS
Gauge Pressure	ADT761-L	-0.95 to 7 bar (-13.5 to 100 psi)	-0.95 to 2.5 bar (-13.5 to 35 psi)	0.02%FS	0 to 7 bar (0 to 100 psi)	0.02%FS

Table A-1 Pressure ranges

Type	Model	Pressure Range	Pressure Module 1		Pressure Module 2	
			Range	Accuracy	Range	Accuracy
Gauge Pressure	ADT761-M	-0.90 to 25 bar (-13 to 375 psi)	-0.9 to 2.5 bar (-13 to 35 psi)	0.02%FS	0 to 25 bar (0 to 375 psi)	0.02%FS
	ADT761-H	-0.90 to 40 bar (-13 to 600 psi)	-0.9 to 2.5 bar (-13 to 35 psi)	0.02%FS	0 to 40 bar (0 to 600 psi)	0.02%FS
Gauge/Absolute Pressure	ADT761-LA	-0.95 to 7 bar (-13.5 to 100 psi)	-0.95 to 2.5 bar (-13.5 to 35 psi)	0.02%FS	-0.95 to 7 bar (-13.5 to 100 psi)	0.02%FS
		0.05 to 8 bar.a (1.2 to 115 psi.a)	0.05 to 3.5 bar.a (1.2 to 50 psi.a)	0.03%FS	0.05 to 8 bar.a (1.2 to 115 psi.a)	0.025%FS
	ADT761-MA	-0.90 to 25 bar (-13 to 375 psi)	-0.9 to 2.5 bar (-13 to 35 psi)	0.02%FS	-0.9 to 25 bar (-13 to 375 psi)	0.02%FS
		0.1 to 26 bar.a (1.7 to 390 psi.a)	0.1 to 3.5 bar.a (1.7 to 50 psi.a)	0.03%FS	0.1 to 26 bar.a (1.7 to 390 psi.a)	0.025%FS
	ADT761-HA	-0.90 to 40 bar (-13 to 600 psi)	-0.9 to 2.5 bar (-13 to 35 psi)	0.02%FS	-0.9 to 40 bar (-13 to 600 psi)	0.02%FS
		0.1 to 41 bar.a (1.7 to 615 psi.a)	0.1 to 3.5 bar.a (1.7 to 50 psi.a)	0.03%FS	0.1 to 41 bar.a (1.7 to 615 psi.a)	0.025%FS
Barometric pressure	ADT761-BP	100 to 1,200 hPa	100 to 1,200 hPa	0.01%FS	N/A	N/A

Table A-1 Pressure ranges

Note 1: One year accuracy (including yearly stability).

Note 2: Barometric reference: Range(700~1100)hPa, Accuracy0.5hPa.

- ◆ Control stability: 0.005%FS.
- ◆ Response time: < 30sec. (regarding a 20% press, increase in a 50cc test volume in high speed mode).
- ◆ Pressure media: clean dry non-corrosive gases.
- ◆ Electrical measurements (ambient temperature 20 °C ±5 °C, 1 year accuracy).

Signal	Range	Resolution	Accuracy
Voltage	(-30.0000 ~ 30.0000)V	0.1mV	0.01%RD+1.5mV
Current	(-30.0000 ~ 30.0000)mA	0.1µA	0.01%RD+1.5µ
Switch	Test voltage DC 3V ~ DC 24V		

Table A-2 Electrical measurements

Note 1: temperature coefficient < ±0.0015% RDG / °C outside of (15~25) °C.

Note 2: input features:

- 1) Voltage measurement: input impedance > 1MΩ. Max input voltage is ±300V DC.
- 2) Current measurement: input impedance < 10Ω. Max input current is ±1A DC.

- ◆ Electrical source (ambient temperature 20 °C ±5 °C, 1 year accuracy).

Signal	Range	Resolution	Accuracy
Current	(0 ~ 22.000)mA	1µA	0.02%RD+2.2µA
Loop supply	24V	N/A	±0.5V

Table A-3 Electrical source

Note 1: temperature coefficient $< \pm 0.0015\% \text{ RDG} / ^\circ\text{C}$ outside of $(15\sim 25)^\circ\text{C}$.

Note 2: input features:

1) Current source: in the internal power mode maximum load current is $20\text{mA}@1\text{k}\Omega$. In the external power mode $(0\sim 36\text{V})$ the peak load meets: $\text{output current} * \text{load resistance} < (\text{voltage} - 4)\text{V}$.

2) Short circuit protected.

- ◆ Display: 7.0" 800×480 pixels color LCD.
- ◆ Dimensions and weight: 296 (w) * 186(h) * 180(d) mm, and approx. 5.6kg.
- ◆ Electrical interface: $\Phi 4\text{mm}$ electrical jack.
- ◆ Charging interface: 2 pin aviation connector.
- ◆ RS-232 interface: RS-232-DB9 female.
- ◆ Pressure module interface: 5 pin aviation connector.
- ◆ Compatible with Additel/Land software which is available for a free download at <http://www.additel.com/products/Software/>.



Additel Corporation

22865 Savi Ranch Parkway Ste F

Yorba Linda, CA 92887, USA

Phone: 714-998-6899

Email: service@additel.com

website: www.additel.com