



ADT672 DIGITAL PRESSURE CALIBRATOR



ADT 672 DIGITAL PRESSURE CALIBRATOR

————— User's Manual

[Version No.: 1410V13]

Please download the latest version via www.additel.com



Additel Corporation

CONTENTS

WELCOME TO YOUR ADT672	1
FOR YOUR SAFETY	2
SPECIFICATION	3
DESCRIPTION	6
1.0 Summary	6
1.1 Basic configuration	7
1.2 Terminal introduction	8
1.3 Keypad	8
<i>1.3.1 Definition</i>	8
<i>1.3.2 Data inputting function</i>	9
1.4 Display introduction	9
1.5 Main interface definition	10
1.6 Menu introduction	11
<i>1.6.1 Enter into menu</i>	11
<i>1.6.2 Operation steps</i>	11
<i>1.6.3 Main menu</i>	12
<i>1.6.4 Calibration menu</i>	13
1.7 Power supply introduction	14
MAIN INTRODUCTION	15
2.0 Power on/off	15
2.1 Pressure measure function	15

2.1.1	Pressure units	15
2.1.2	Pressure zeroing	16
2.1.3	Pressure % indication	17
2.1.4	Peak pressure record	17
2.1.5	Overpressure warning	18
2.1.6	Resolution adjustment	18
2.2	Electricital measure function	19
2.2.1	Switch measure items	19
2.2.2	Electricital measure	19
2.2.2.1	Current zeroing	19
2.2.3	Voltage measure	19
2.2.3.1	Voltage zeroing	19
2.2.4	Temperature measure	19
2.2.5	Pressure switch measure	19
2.2.5.1	Operation	20
2.2.5.2	Attentions	21
2.2.6	Count-down leak test	21
2.2.7	Switch display resolution	22
2.3	DC24V output function	22
2.3.1	Power on/off DC24V	22
2.3.2	DC24V Timing output	23
2.3.3	Protection for short-circuiting and over current	23
2.4	Backlight function	23
2.5	Buzzer function	23

2.6 Adjust real time function	24
2.7 RS232 communication function	25
2.7.1 Set RS232 serial port	25
2.7.2 Submit data automatically	25
2.7.3 Communication instructions	25
2.7.4 Software	26
DATA LOGGER FUNCTION	26
3.0 Basic introduction	26
3.1 How to operate save menu	26
3.1.1 See the saved file	27
3.1.2 Delete data	28
3.1.3 Send data via serial port	29
3.1.4 Set file attributes	29
3.1.5 Delete all data	29
3.1.6 Send all files via serial port	30
3.1.7 Set save mode	30
3.1.8 Enter save-file status	31
3.1.9 Quit save-file status	31
3.2 Use manual mode	32
3.3 Use hour-record function	32
3.4 Use interval-record function	33
3.5 Automatic logging with startup	34

HART COMMUNICATION FUNCTION	34
4.0 Connect HART.....	34
4.1 Set inner/external sampling resistance.....	35
4.2 HART communication operation.....	35
4.3 Display status.....	36
4.4 Detective linkage.....	36
4.5 HART function introduction.....	37
4.5.1 Function 1: Display SENSOR range.....	40
4.5.2 Function 2: Display PV range, switch PV unit, transfer PV range.....	41
4.5.3 Function 3: Display and adjust damp time.....	42
4.5.4 Function 4: display CP value and PV value.....	43
4.5.5 Function 5: display CP value and AO value.....	43
4.5.6 Function 6: Display CA and AO value.....	44
4.5.7 Function 7: Loop analog current test, AO calibration.....	44
4.5.8 Function 8: PV calibration process.....	46
4.5.9 Function 9: Special calibration function.....	48
CALIBRATION FUNCTION	49
5.0 Introduction.....	49
5.1 Calibration condition.....	49
5.2 Calibration menu's operation and content.....	49
5.3 Pressure calibration.....	49
5.4 Cancel pressure calibration.....	52
5.5 Current calibration.....	52

5.6 Cancel current calibration	52
5.7 Voltage calibration	52
5.8 Cancel voltage calibration	52
5.9 Cancel previous pressure zeroing	52
6.0 Accessories	53
APPENDIX I: THE TYPICAL APPLICATION OF ADT672	54
(1) Pressure dial gauge calibration	54
(2) Pressure switch calibration	55
(3) Pressure transmitter calibration	56
APPENDIX II: COMMUNICATION PROTOCOL	57
(1) Instruction format	57
(2) Instruction details	58
(3) The file's transfer format	62
(4) Pressure units shortening list	62
(5) Pressure units info code	62
(6) The format of automatically data transfer	62
(7) Wrong sequence number explanation	63
(8) HART function's return format	63



Welcome to your ADT672

This detailed user's manual will help you become familiar with the many features of ADT672 Calibrator. The simple step-by-step instructions will quickly guide you through the procedures for using the calibrator and other items needed for accurately testing and calibrating numerous types of instruments.

All products made by Additel are warranted to be free of defects in workmanship and materials for 1 year from the date of shipment. No other express warranty is given, and no affirmation of Seller, by words or actions, shall constitute a warranty. SELLER DISCLAIMS ANY IMPLIED WARRANTIES OF MERCHANTABILITY OR FITNESS FOR ANY PARTICULAR PURPOSES WHATSOEVER.

If any defect in workmanship or material should develop under conditions of normal use and service within the warranty period, repairs will be made at no charge to the original purchaser, upon delivery of the product(s) to the factory, shipping charges prepaid. If inspection by Additel or its authorized representative reveals that the product was damaged by accident, alteration, misuse, abuse, faulty installation or other cause beyond the control of Additel, this warranty does not apply.

ADDITEL MAKES NO WARRANTY OF ANY KIND WITH REGARD TO THIS MANUAL, INCLUDING, BUT NOT LIMITED TO, THE IMPLIED WARRANTIES OF MERCHANTABILITY AND FITNESS FOR A PARTICULAR PURPOSE.

Please Notice: The product specifications and other information contained in this manual are subject to change without notice. Additel has made a concerted effort to provide complete and current information for the proper use of the equipment. If there are questions regarding this manual or the proper use of the equipment, contact Additel at:

TEL: (714)998-6899

E-MAIL: service@additel.com

FAX: (714)998-6999

WEB: www.additel.com

For your safety

Media & Overpressure:

- ▶ (-100kPa ~ 400kPa): Non-corrosive and unpolluted gas;
(Higher than 400kPa): media compatible with 316 Stainless Steel.
- ▶ Overpressure: 120%.
- ▶ Burst pressure: 300%.

Warning:

- ▶ Follow all equipment safety procedures.
- ▶ Do not operate the calibrator around explosive gas, vapor, or dust.
- ▶ Do not put the battery in the fire or make electricity short circle; Use charger supplied by Additel only.
- ▶ Never apply more than 32V between mA terminal and common terminal.
- ▶ Recharge or replace the battery as soon as the battery indicator  appears.
- ▶ Do not allow water inside the case, please clean and maintain the calibrator periodically.
- ▶ Do not apply more than 11V voltage to rechargeable jack. Any problem caused by this is not covered under warranty.
- ▶ To avoid over pressure damages, do not apply pressure that exceeds the limits listed in the pressure specification table.
- ▶ To avoid mechanically damaging the calibrator, do not apply torque between the pressure fitting and the calibrator case.
- ▶ Do not disassemble the calibrator. Any problem caused by this is not covered under warranty.



Specification

◆ Pressure ranges

Gauge Pressure ^[1]					
P/N	Pressure Range (psi)	Pressure Range (bar)	Media ^[2]	Accuracy (% FS)	Burst Pressure
V15	-15	-1.0	G	0.025 (0.05)	3 X
GP2	2	0.16	G	0.025 (0.05)	3 X
GP5	5	0.35	G	0.025 (0.05)	3 X
GP10	10	0.7	G	0.025 (0.05)	3 X
GP15	15	1.0	G, L ^[3]	0.025 (0.05)	3 X
GP30	30	2.0	G, L ^[3]	0.025 (0.05)	3 X
GP50	50	3.5	G, L	0.025 (0.05)	3 X
GP100	100	7.0	G, L	0.025 (0.05)	3 X
GP300	300	20	G, L	0.025 (0.05)	3 X
GP500	500	35	G, L	0.025 (0.05)	3 X
GP600	600	40	G, L	0.025 (0.05)	3 X
GP1K	1,000	70	G, L	0.025 (0.05)	3 X
GP2K	2,000	140	G, L	0.025 (0.05)	3 X
GP3K	3,000	200	G, L	0.025 (0.05)	3 X
GP5K	5,000	350	G, L	0.025 (0.05)	3 X
GP10K	10,000	700	G, L	0.025 (0.05)	2 X
GP15K	15,000	1,000	G, L	0.05 (0.1)	2 X
GP20K	20,000	1,400	G, L	0.1	1.5 X
GP25K	25,000	1,600	G, L	0.1	1.5 X
GP30K	30,000	2,000	G, L	0.1	1.5 X
GP36K	36,000	2,500	G, L	0.1	1.5 X
GP40K	40,000	2,800	G, L	0.1	1.1X

Absolute Pressure					
P/N	Pressure Range (psi)	Pressure Range (bar)	Media	Accuracy (% FS)	Burst Pressure
AP5	5	0.35	G	0.1	3 X
AP10	10	0.7	G	0.1	3 X
AP15	15	1.0	G	0.1	3 X
AP30	30	2.0	G	0.1	3 X
AP50	50	3.5	G	0.1	3 X
AP100	100	7.0	G, L	0.05 (0.1)	3 X
AP300	300	20	G, L	0.05 (0.1)	3 X
AP500	500	35	G, L	0.05 (0.1)	3 X
AP1K	1000	70	G, L	0.05 (0.1)	3 X
AP3K	3000	200	G, L	0.05 (0.1)	3 X
AP5K	5000	350	G, L	0.05 (0.1)	3 X

Differential Pressure					
P/N	Pressure Range (inH ₂ O)	Pressure Range (mbar)	Media	Accuracy (% FS)	Burst Pressure
DP1	1	2.5	G	0.05 ^[4]	100 X
DP2	2	5.0	G	0.05 ^[4]	100 X
DP5	5	10	G	0.05	50 X
DP10	10	25	G	0.05	20 X
DP20	20	50	G	0.05	20 X
DP30	30	100	G	0.05	20 X
DP50	50	160	G	0.05	3 X
DP150	150	350	G	0.025	3 X
DP300	300	700	G	0.025	3 X

Compound Pressure					
P/N	Pressure Range (psi)	Pressure Range (bar)	Media	Accuracy (% FS)	Burst Pressure
CP2	2	0.16	G	0.05	3X
CP5	5	0.35	G	0.025(0.05)	3X
CP10	10	0.7	G	0.025(0.05)	3X
CP15	15	1	G	0.025(0.05)	3X
CP30	-15 to 30	-1 to 2	G	0.025(0.05)	3X
CP100	-15 to 100	-1 to 7	G, L	0.025(0.05)	3X
CP300	-15 to 300	-1 to 20	G, L	0.025(0.05)	3X

Note: [1]. Sealed gauge pressure for above 1000 psi

[2]. G=Gas, L=Liquid

[3]. 0.025% FS for gas media only

[4].* One year accuracy (including yearly stability) except DP1 and DP2 range which is 0.05%FS calibration accuracy and 0.05%FS yearly stability.

- ◆ **Pressure units:** mmH₂O@4°C, mmHg@0°C, psi, kPa, MPa, Pa, mbar, bar, inH₂O@4°C, inHg@0°C (all units may not be displayed for all ranges).
- ◆ **Overpressure warning:** The screen will flash if measuring pressure over 120%FS.
- ◆ **Electricity measure and Source Accuracy:**

	Range	Accuracy
Voltage DC	30.0000V	(0.01%RD + 1.5 mV)
Current DC	30.0000mA	(0.01%RD + 1.5 μA)
DC 24V	24V 0.5V max:50mA Protect at: 120mA	
Switch ^[1]	Status OPEN/CLOSED	

Description

1.0 Summary

The ADT672 is a portable digital pressure calibrator designed to be a rugged calibration tools which has the functions to calibrate and maintain pressure instruments.

Features:

- ① High-accuracy pressure measure & wide-range temperature compensation
- ② Measure function to mA, V and switch
- ③ HART communication
- ④ DC24V output
- ⑤ RS232 port to connect with computer
- ⑥ Data logging
- ⑦ Assistant measure function for time and temperature
- ⑧ A/C or D/C (rechargeable battery)

According to about functions, ADT672 also have some other common functions as below:

- ① Record the peak pressure
- ② Indicate % pressure
- ③ Pressure leak test
- ④ Trigger switch control
- ⑤ Data logging
- ⑥ Communicate with HART pressure transmitter

As a master gauge(or reference gauge), ADT672 digital pressure calibrator is to measure or calibrate pressure instruments such as pressure transmitters, differential pressure sensors, pressure switches, precision pressure gauges, industry pressure gauges, sphygmomanometers, pressure transducer and others.

1.1 Basic configuration

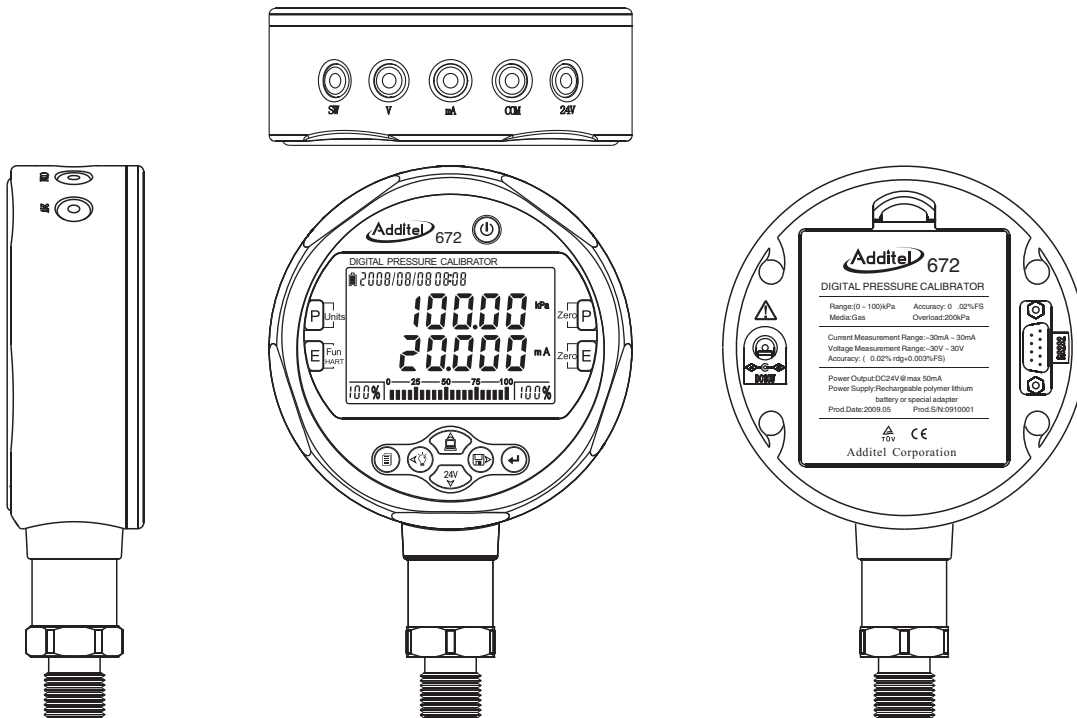

Figure 1-1: Configuration view

1.2 Terminal introduction

As basic configuration view, Figure 1–1, the ADT672 have 5 standard Φ 4mm terminals, from left:

- ⊙SW: Positive terminal for switch measure, red color.
- ⊙V: Positive terminal for voltage measure, red color.
- ⊙mA: Positive terminal for current measure, red color.
- ⊙COM: Communal terminal, black color.
- ⊙24V: Positive terminal for D/C output, red color.

1.3 Keypad Introduction

1.3.1 Definition

 Power on/ off.

 Switch pressure units.

 Pressure to zero (gauge/differential pressure range: $-1\%FS\sim 1\%FS$; as for absolute pressure, please refer 2.1.2).

 Current/voltage to zero (Range: $-0.2\%FS\sim 0.2FS$).

 1st function: switch measure type by the sequence of current/voltage/temperature/pressure switch/count-down;
2nd function: enter or exit HART linkage status.

 1st function: Press it to enter into basic function menu or password inputting menu;
2nd function: Cancellation (ESC).

 Confirmation (✓).

 1st function: backlight; 2nd function: move decimal digit left(←).

 1st function: Under the status of file saving, press it once to save a new record or exit;

2nd function: Under the status of non-saving, press it to enter into the save file menu;

3rd function: Move decimal digit right (→).

 1st function: Press to send out data via serial port;

2nd Adjust the resolution between 5 and 6 digits;



3rd function: Move decimal digit up (↑).

 1st function: Turn on/ off DC24V power;



2nd function: Switch the display resolution of current/voltage/temperature;

3rd function: move decimal resolution down (↓).

1.3.2 Data inputting function

 (←),  (→) Move decimal digit left and right

 Confirm the inputted data (←)

 (↑),  (↓) Increase/decrease the pressure value

 Cancel the inputted data (ESC).

1.4 Display introduction

▶ **Battery level:** Three bars show the battery level, ADT672 will auto shut off if battery is too low.

▶ **Date and time:** 【Year/Month/Day Hour: Minute】 .

▶ **Communication:** If this icon is appear, 3 roll bars indicate the ADT672 is sending out the data via RS232.

- ▶ **24V:** This icon shows if 24V is turned on or off.
- ▶ **Pressure reading:** display the measuring pressure value.
- ▶ **Pressure units:** display the selected pressure units.
- ▶ **HART status:** The icon HART shows the communication status, and the character ⊗ shows the HART function.
- ▶ **Count-down icon:** The cursor starts to rotate when in count-down mode.
- ▶ **Electricity reading:** display the measuring electricity value.
- ▶ **Electricity units:** display the measuring current/voltage units.
- ▶ **Status area:** indicate % pressure; the % saving files.
- ▶ **Left reading area:** It shows the actual pressure percentage (0%~199%);In data logging, it indicates file number at present.
- ▶ **Right reading area:** It shows the actual pressure percentage (0%~199%);
In data logging, it indicates all quantity of saved files.

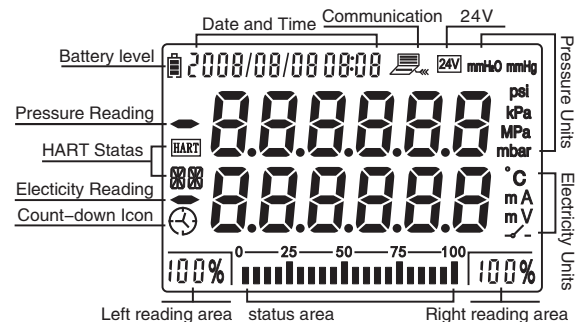

Figure 1-4: Screen introduction

1.5 Main interface definition

The interface of ADT672 includes main interface and menu interface.

Main interface displays all measuring data, as figure 1-5. After ADT672 is turned on, the menu interface displays two kinds of status.

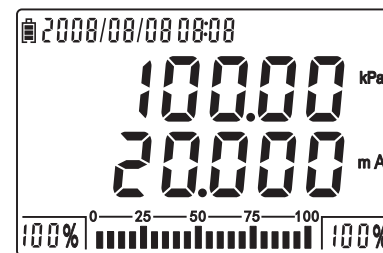

Figure 1-5: Main interface

(1) The default of main interface is:

- ▶ Electrical measure mode is current, five digits display
- ▶ Pressure measure displays five digits
- ▶ The pressure unit defaults to the pressure unit selected at time of order

Example: As to the calibrator with (0~100) kPa, the default pressure unit is kPa.

(2) When in data logging mode, the default of main interface is:

- ▶ The electrical measure mode is five digits
- ▶ Pressure measure displays five digits
- ▶ The pressure unit defaults to the pressure unit selected at time of order

1.6 Menu introduction

1.6.1 Enter into menu

Includes main function menu and calibration menu, refer figure1-6-1.

1.6.2 Operation steps



Enter main menu Select sub-menu Enter sub-menu

Press to return to the previous menu or exit.

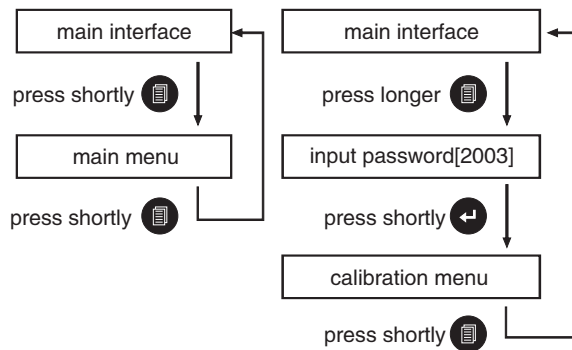
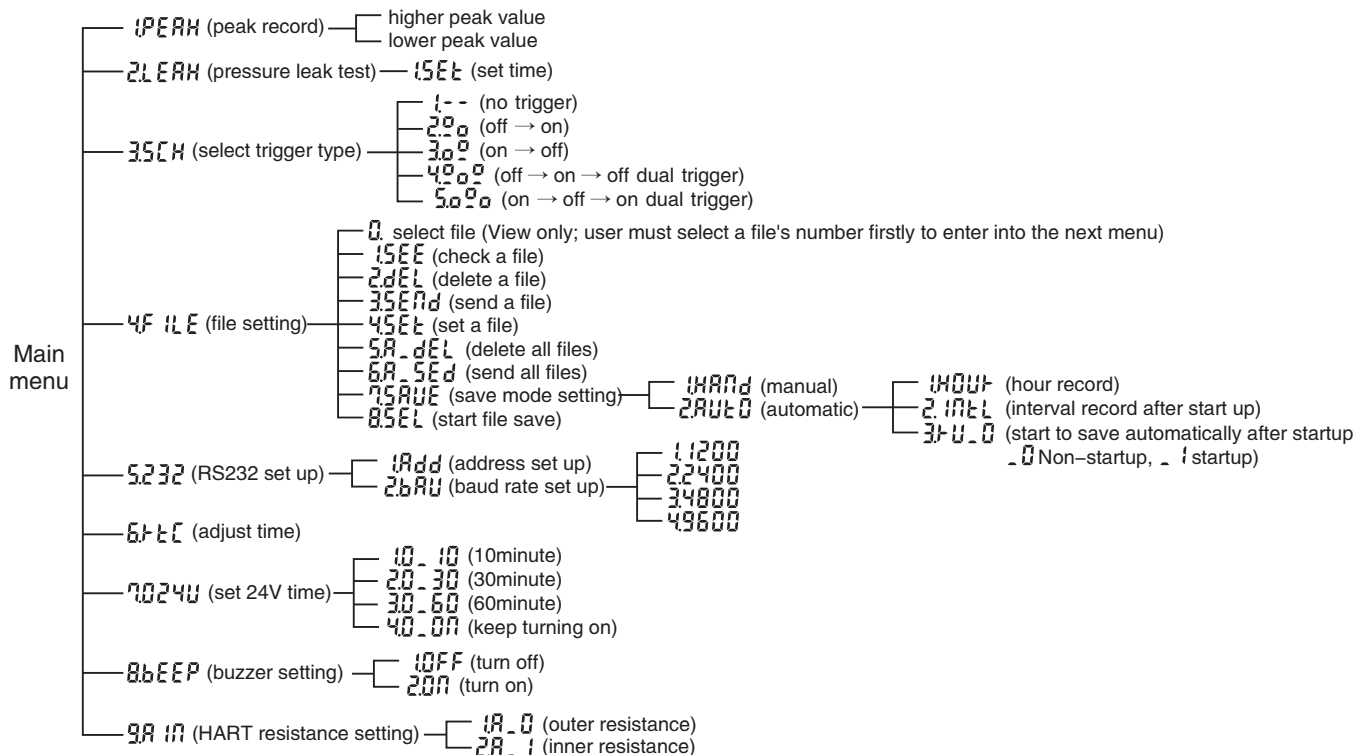



Figure 1-6-1: How to enter into the menu

1.6.3 Main menu



1.6.4 Calibration menu

calibration menu	0PASS-	input password(2003)
	1P.CAL	(pressure calibration)
	2P.0 / 1	(pressure calibration executed, cancel calibration)
	3I.CAL	(current calibration)
	4I.0 / 1	(current calibration executed, cancel calibration)
	5V.CAL	(voltage calibration)
	6V.0 / 1	(voltage calibration executed, cancel calibration)
	7ZET0	(zeroing before pressure is canceled)

N.B: ①  Not a selectable menu item but for viewing only. If enter into the menu, please input the correct password.

②  The calibration status. 0: Not calibrated, 1: calibrated. Caution: once selected the prior results can't be restored. The calibration methods of current/voltage are same as pressure calibration.

1.7 Power supply introduction

ADT672 have two kinds power source: special 10V adapter and rechargeable battery.

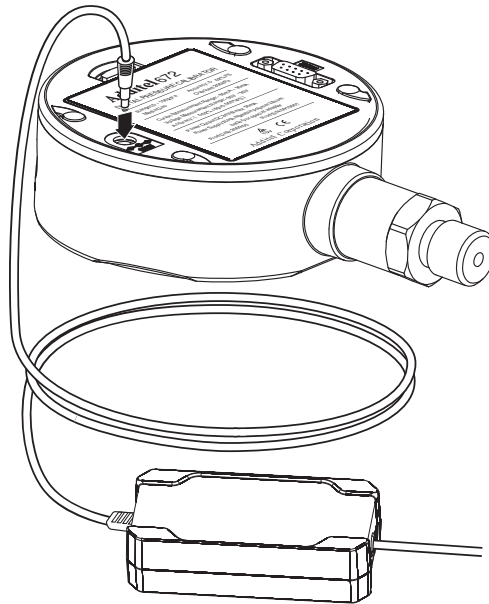

Adapter Model:Model number 9814

Figure 1-7-1: recharge

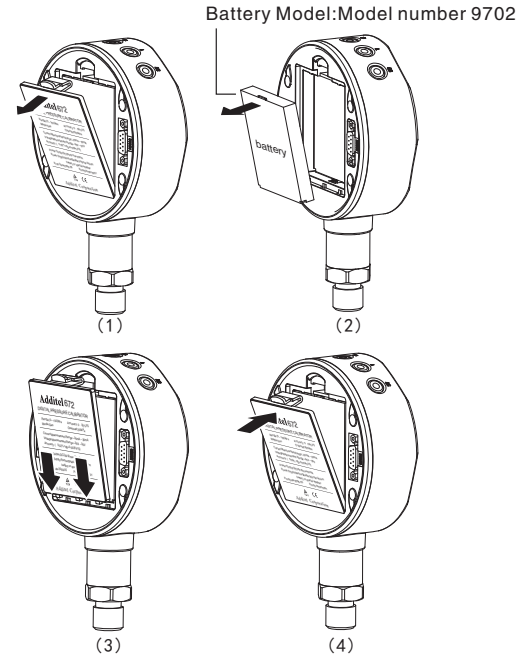

Figure 1-7-2: replace a new battery

- ① Battery model: Model number 9702 Type: Polymer Li-ion rechargeable battery Standards: 7.4V/8.4V, 1600mAh
- ② Adapter mode: Model number 9814 Input: AC85V ~ AC245, 50Hz/60 Hz
- ③ The icon indicates the battery level, please recharge or replace a new battery timely if the icon appears.
- ④ The rechargeable time is four hours.
- ⑤ Follow all safety regulations and use adapter from Additel only.

Basic function introduction

2.0 Power on/off

By pressing , ADT672 will be powered on/ off. The displayed sequence is model number, pressure ranges and the main menu. The startup interface as figure 2-1.

2.1 Pressure measure function

2.1.1 Pressure units

By pressing , the pressure units can be switched by the sequence of **Pa, kPa, Mpa, mbar, bar, psi, mmH₂O, mmHg, inH₂O, inHg**

Remark: In order to properly display the pressure reading, some units may not be available for certain pressure ranges.

The conversion relation as below:

Pa	kPa	MPa	mbar	bar	psi	mmH ₂ O	mmHg	inH ₂ O	inHg
1000	1	0.001	10	0.01	0.14504	101.974	7.50061	4.01463	0.2953

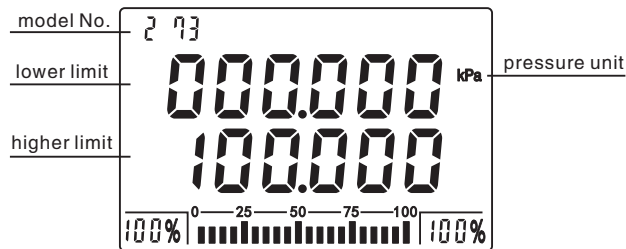

Figure 2-0: Start up interface

2.1.2 Pressure zeroing

Zero the pressure measurement by pressing .

(1) Gauge or differential pressure:

zero if the measuring pressure is in the range of $(-1\% \sim 1\%)$ FS. First, connect the pressure port with atmosphere. Then after the data is steady, press to zero.

(2) Absolute pressure:

It is difficult to pull a hard vacuum to absolute zero. Because of this we have developed the following zeroing procedure to zero the ADT672 absolute sensors.

a. Connect the ADT672 to a vacuum source or to atmosphere, with a reference standard. The reference pressure is **Pstandard**. The ADT672 is **Pmeasure**.

The ADT672 will need to be zeroed if there is a difference between **Pstandard** and **Pmeasure**.

b. The first digital starts to flash by pressing . Input the pressure value **Pstandard**.

c. Zeroing operation is finished if the pressure is changed from **Pmeasure** to **Pstandard**.

Attention: User could cancel the previous zeroing by select the 7th option .

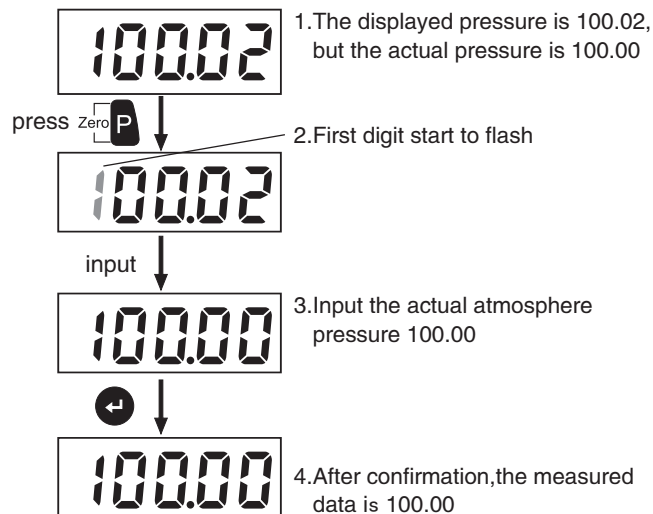

Figure 2-1-2: Absolute pressure to zero

2.1.3 Pressure % indication

The % pressure is indicted by the status area, including:

- ① Left reading area: Range is (0%~199%)FS; minimum resolution is 1%;
- ② Right reading area: Range is (0%~199%)FS; minimum resolution is 1%;
- ③ Status area: Range is (0%~100%)FS; minimum segment is 5%.

When in the non-data logging function, three areas are relative to the measuring pressure P. The calculation formula is below:

- ▶ Positive pressure (0~PH): $\% = | P | / PH$;
- ▶ Negative pressure (PL ~0): $\% = | P | / | PL |$;
- ▶ Compound pressure (PL ~ 0~PH): $\% = | P | / PH$; condition $[P \geq 0]$;
 $\% = | P | / | PL |$; condition $[P < 0]$.

Example: ADT672 w/ (0~2)MPa, status area as figure 2-1-3 if the pressure is 1MPa.



Figure 2-1-3 % status area





2.1.4 Peak pressure record

The ADT672 self-records the maximum and minimum pressure. The peak value can be checked or cleared by selecting **! PEAK**. The operation steps as following:

! PEAK. The operation steps as following:

(1) In the main interface, the pressure value is P.

(2) Press  to enter into Main menu, use   to select **! PEAK** (PEAK), and press .

- (3) Screen shows the maximum and minimum pressure value.
- (4) Press  to clear the maximum and minimum pressure, and set P as the current pressure.
- (5) Select the suitable pressure unit by pressing .
- (6) Return to main menu by pressing .
- (7) Return to main interface by pressing , and start to record the maximum pressure and minimum pressure.
- (8) If there is any higher or lower peak value, the ADT672 will record it automatically and replace the previous peak value.
- (9) After a while, user can repeat step (2), (3) to check the peak value, and repeat the step (6), (7) to exit.
- (10) If user needs to record a new peak value, please repeat the steps (1) ~ (7).

2.1.5 Overpressure warning

If a overpressure condition occurs, the buzzer will continuously beep until it is below 120%. Attention: Regardless of the buzzer on/off condition, it will continue to beep to indicate and over pressure condition.

The warning conditions: (Assumes the pressure is P)



- ▶ Positive pressure (0~PH): $|P| > 1.2 * PH$;
- ▶ Negative pressure (PL ~0): $|P| > 1.2 * |PL|$;
- ▶ Compound pressure (PL ~ 0 ~ PH): $|P| > 1.2 * PH$, if $[P \geq 0]$;
 $|P| > 1.2 * |PL|$, if $[P < 0]$.

2.1.6 Resolution adjustment

In the main interface, press  to switch the pressure reading between 5 and 6 digits.

2.2 Electrical measure function

2.2.1 Switch measure items

By pressing  , switch the measure items by the sequence of current(mA), voltage(V), environment temperature(°C), switch  , counting-down pressure leak test  .

2.2.2 Electrical measure

Electrical terminal is: mA COM

2.2.2.1 Current zeroing

If it is in the range of (0~ 0.2%FS), please clear the current value to zero by pressing 

2.2.3 Voltage measure

Electricity terminal is: V COM

2.2.3.1 Voltage zeroing





If it is in the range of (0~ 0.2%FS), please clear the voltage value to zero by pressing 

2.2.4 Temperature measure

The range is (-20~80)°C and resolution is 0.1°C. This function is to measure the internal temperature of ADT672.

2.2.5 Pressure switch measure

Electrical terminal is SW COM

Indication icons:  is switching off  ;  is switching on  .

There are five triggering modes as listed below:

- (1) Press to enter into the main menu, select 3.5CH (SWITCH) by using and confirm .
- (2) Screen shows triggering mode menu, please select the suitable mode by using and confirm .

2.2.5.1 Operation

The factory default is trigger is off.

- (1) **No trigger:** Monitor switch status and the screen is not in a locked condition.
- (2) **Triggering off→on:** The screen is locked while the trigger is being changed. Also, the screen shows the pressure value and switch status. Press to restart a new trigger.
- (3) **Trigger on→off:** The screen is locked while the trigger is changed. Also, the screen shows the pressure value and switch status. Press to restart a new trigger.
- (4) **Trigger off→on→off:** It is combined by the mode 2 (off→on) and mode 3 (on→off), it have three steps as following:
 - 1st step: The screen is locked after it is changed from "off" to "on", please unlock the screen by pressing ;
 - 2nd step: The screen is locked after the trigger status changed from

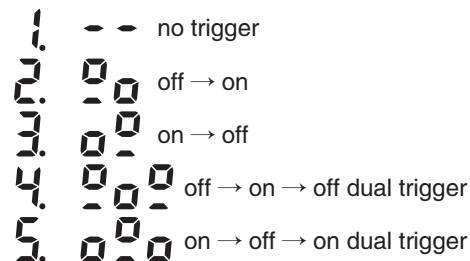

Figure 2-2-5: Trigger mode selection

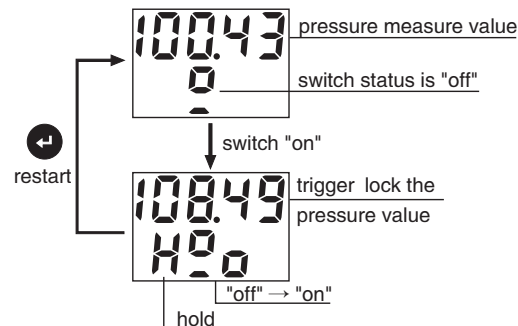





Figure 2-2-5-1: trigger "off"→"on" process

"on" to "off", please unlock the screen by pressing  ;

3rd step: Go back to 1st step to restart the trigger.

(5) **Triggering on→off→on**: It is combined by the mode 3 (on→off) and mode 2 (off→on), it has three steps as below:

1st step: The screen is locked after it is changed from "on" to "off", please unlock the screen by pressing  ;

2nd step: The screen is locked after the trigger status changed from "off" to "on", please unlock the screen by pressing  ;

3rd step: Go back to 1st step to restart the trigger.

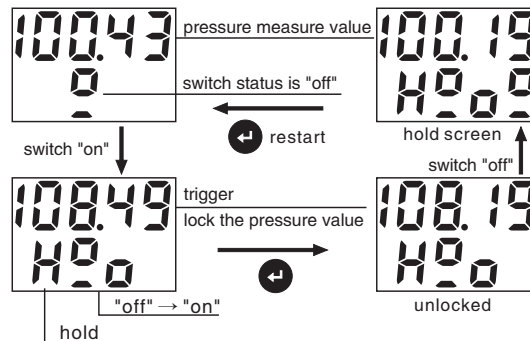



Figure 2-2-5-2 "off" → "on" → "off" dual triggering

2.2.5.2 Attention

- (1) Switch can take D/C (1~12V). Please distinguish the anode and cathode.
- (2) At the status of file saving and trigger mode, the ADT672 will save one record automatically at the moment of triggering and there is no need to press  .

2.2.6 Count-down leak test

This function is to measure the chamber's sealed performance, as below:

- (1) Connect the ADT672 with chamber, supply a certain pressure **P1**.
- (2) Please record the second pressure **P2** when the set time **T** is arrived.
- (3) According to the margin of **P1 - P2**, user can confirm if the sealed performance is good.



Please refer the figure 2-2-6-1 for pressure leak test process. The maximum time is 99 hours 59 minutes and 59 seconds. The default is 10 seconds. It can be set in the main menu, as below:

- (1) Please select the **2LEAK** (LEAK) and **1SEt** (SET).
- (2) As figure 2-2-6-2, please input the time as format **[hour: minute: second]** , confirm it and return the main interface by pressing  .





2.2.7 Change display resolution

In the main interface, pressure value is switched between 5 digits and 6 digits by pressing  .

2.3 DC24V output function

Electricity terminal is  24V  COM.

2.3.1 Power on/off DC24V

In the main interface, please turn on the DC24V output by pressing  (icon  appear). Press  again to close the DC24V (icon  disappears). It is suggested to turn off the DC24V function if it is not used.

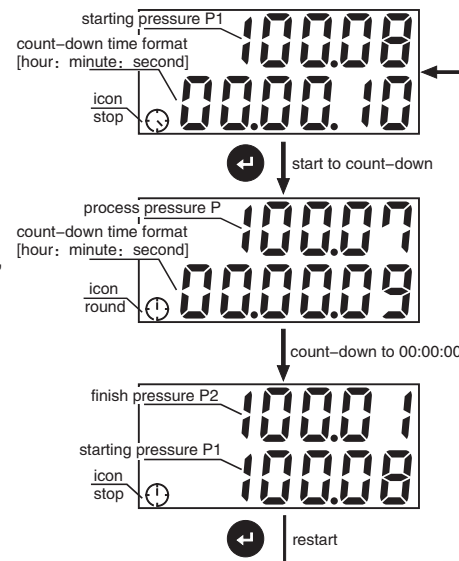

Figure 2-2-6-1: Count-down leak test



Figure 2-2-6-2: Count-down time setting

2.3.2 DC24V timing output

This function is to protect the unnecessary power consumption if user forgets to close DC24V.

The operation steps as following:

- (1) Please select **7.024V** (output 24V) in the main menu.
- (2) As figure 2-3-2 Screen, screen shows the time options of DC24V output.
- (3) When the selected time is up, the DC24V output is closed automatically.

Remark: under the condition of HART communication, DC24V output function is not enabled.

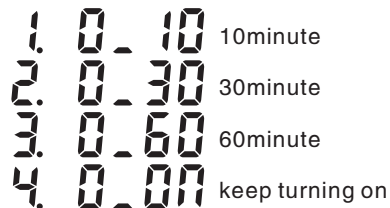

Figure 2-3-2 DC24V time setup

2.3.3 Protection for short-circuiting and over current

ADT672 will turn off and beep automatically if there is any short-circuit or over current(>150mA) between  24V and  COM.

When the alert ceases, DC24V will go back to normal status.

2.4 Backlight function

In the main interface, press  to control the backlight.

2.5 Buzzer function

User can set up buzzer status as below:

- (1) Select the **8bEEP** (BEEP) in the main menu.
- (2) Select on or off to enable or disable the buzzer (see figure 2-5).



Figure 2-5 Buzzer option

Remark:

- ▶ *The factory default setting is on, meaning the buzzer is enabled.*
- ▶ *Buzzer will beeps under the following conditions :*
 - (1) *Correct keystroke beeps once, and the incorrect beeps twice.*
 - (2) *Over measure warning.*
 - (3) *The correct communication instruction beeps once.*
 - (4) *The plugging adapter beeps once.*
 - (5) *For short-circle or over current, it continuously beeps.*
 - (6) *The sound is once if the ADT672 is turned on or off.*
 - (7) *Under the automatic save mode, it beeps once while each record is saved.*
 - (8) *For switch status changing, it beeps once.*
 - (9) *If the count-down time is up, it beeps once.*

2.6 Adjust real time function

The display format is **【Year/Month/Day Hour: Minute】** , year' s range is 2000~2099, time is 24 hour format.

- (1) Select **676C** (RTC) in the main menu.
- (2) Input the date and time, see figure 2-6.



Figure 2-6: Adjust o'clock

2.7 RS232 communication function

2.7.1 Set RS232 serial port





RS232 communication parameter is below:

- ① Address range is (1~112), factory default is 1;
- ② Baud rate is (1200, 2400, 4800, 9600), factory default is 9600;
- ③ The data length default is 8; 2 stop bits; no calibration bit; no data flow control.
- ④ Hardware port: Standard DB9 socket (2 feet is TXD, 3 feet is RXD, 5 feet is GND)

The setup method for address and baud rate is below:

- a. Select the option **5.232** (RS232) in the main menu.
- b. Figure 2-7-1-1 displays the setup menu. User can select the communication address or baud rate.
- c. Figure 2-7-1-2 shows the current address and allows for correction.
- d. The cursor position is displayed in the current option of baud rate if the baud rate is selected.

2.7.2 Submit data automatically

By pressing  , the communication icon  appears and the ADT672 is sending the measuring data via RS232 port, meanwhile, 3 bars rolls in turn; by pressing  again, the icon  disappears and the sending is stopped. Please refer the data sending format in appendix [communication protocols] .

2.7.3 Communication instructions

Please refer the APPENDIX II [communication protocols] for more information.

1. Add (ADDRESS)
2. bAU (BAUD RATE)

Figure 2-7-1-1: Serial port setup

001
cursor beginning position

Figure 2-7-1-2: adjust address

1. 1200
2. 2400
3. 4800
4. 9600



Figure 2-7-1-3: Baud rate option

2.7.4 Software

Please refer to 9500 Additel/Land introduction for more information. Additel/Land is available for free download at <http://www.additel.com/products/Software/>.

Data logger function

3.0 Basic introduction

- ▶ **Memory capacity:** 30 files, 40 records per file.
- ▶ **Manual mode:** Select a file from files (1~30), a record is saved by press  once till the file is full.
- ▶ **Record mode:** including hour record, interval record.
 - ◆ Hour-record: save one record per every hour.
 - ◆ Interval-record: the interval can be set up (1 second ~100 hours).
 - ◆ In the record mode, the files are saved according to the set up sequence.
 - ◆ The record mode defaults to the previous setting.
 - ◆ In the record mode, the keypad is locked. By pressing  to quick save and unlock the keypad.
- ▶ **Save status:** left reading area display the current file number; Right reading area displays the saved records; status area indicate the % of current saved files.

3.1 How to operate save menu

(1) Enter into save menu.

Method 1: Select the **4 F I L E** (FILE) in the basic function menu;

Method 2: Press  button in the main interface.

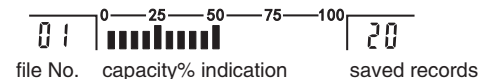

Figure 3-0 Saving area

(2) Select File No. (File operation in menu)

As figure 3-1, select the suitable File No. by using (Range: 1~30), then press to confirm.

(3) File menu options

Select the suitable option by using then press to confirm.

(4) File menu's conten

- ▶ 1SEE (SEE) see the saved file
- ▶ 2DEL (DELETE) delete the file
- ▶ 3SEND (SEND) send out the file
- ▶ 4SET (SET) set file attributes (second gauge #, min scale)
- ▶ 5A_DEL (ALL_DELETE) delete all files
- ▶ 6A_SED (ALL_SEND) Send all files
- ▶ 7SAVE (SAVE) Save the file
- ▶ 8SEL (SELECT) Select to enter into save mode.

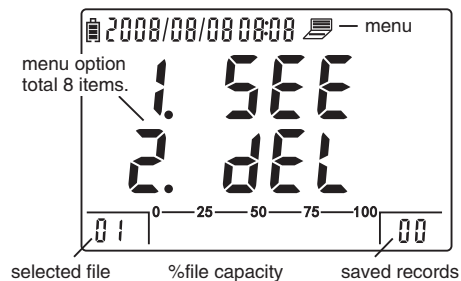

Figure 3-1: Select operation files

3.1.1 See the saved file

Operation method:

a. Select **1SEE**.

b. Screen shows the 1st file's attributes: CODE (second gauge serial No.), factory default is 111111.

- c. By pressing to show the 2nd item: SCALE (minimum scale), default is 00.1000.
- d. By pressing it will directly return to the file menu option, if file is vacant. Otherwise, press once to add a file No. When the last record is checked, it will return to the file menu option by pressing . To quit press .
- (Refer the figure 3-1-1-3)

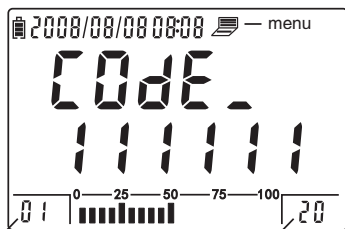

file number %file capacity saved records

Figure 3-1-1-1: second gauge's Serial No.

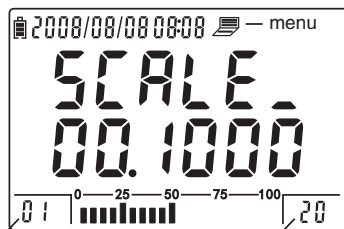

file number %file capacity saved records

Figure 3-1-1-2: minimum scale

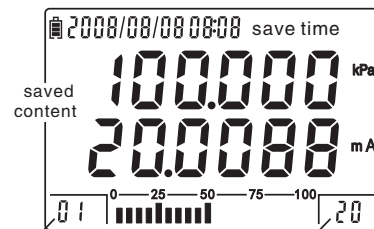

saved content file number %file capacity saved No.

Figure 3-1-1-3: display file's data

Remark: The saved pressure value and electricity value is 6 digits.

3.1.2 Delete data

The operation steps:

- Select **DEL**.
- The deletion process is dynamically displayed in the status area and right and left reading areas. (As figure 3-1-2)
- After deletion, the screen goes back to the file menu option.

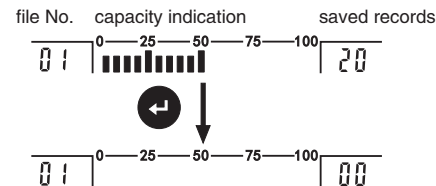

Figure 3-1-2 File deletion process

Remark: This function will delete the file's contents, but not the file's attributes (second gauge's serial No. and minimum scale).

3.1.3 Send data via the serial port

Operation steps:

- After connected the ADT672 and computer via RS232 cable, please startup the serial port receiving software and setup the correct baud rate.
- Select **3SEND**.
- The sending process is dynamically displayed in the two sides of reading area and status area. (Figure 3-1-3)
- After sending the screen goes back to the file menu.



Remark: For sending data format, please refer the appendix II: communication protocol.

3.1.4 Set file attributes

File attributes includes: The CODE of second gauge, min scale division value.

The factory default setting: Second gauge CODE is 111111(6 digits), minimum scale division value: 00.1000 (6 digits).

The setup steps:

- Select **4SET** in the file menu and press .
- Next, screen displays the "CODE "of the second gauge, please input the code and press .
- Screen displays the minimum division value (scale), please input the actual division value and press .
- The screen returns to the file menu automatically.

3.1.5 Delete all data

This function is to delete all data and file attributes, and returns to factory default setting. The operation steps:

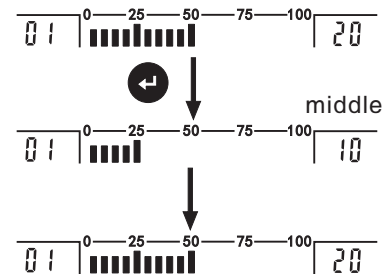

Figure 3-1-3 File upload process

- a. Select **5A_dEL** .
- b. The deletion process is dynamically displayed in the two sides of reading area and status area.
- c. After all files are deleted, the screen returns to the file menu.

Remark: The next operation after all the files are deleted will start from the very beginning of file number 1."

3.1.6 Send all files via serial port

The operation steps:

- a. Connect ADT672 and computer via RS232 cable, start up the receiving software and set the correct baud rate.
- b. Select **6A_SEd** .
- c. The sending process is dynamically displayed in the two sides of reading area and status area.
- d. After all files are sent, it returns to the file menu automatically.

Remark: Please refer sending data format in the appendix II: communication protocol.

3.1.7 Set save mode

The operation steps:

- a. Please select **7SAVE** .
- b. The screen displays two options figure 3-1-7-1.
- c. If select manual mode **1HAND** (HAND), screen returns to the file menu.
Under the manual mode, one record will be saved by pressing  once.
- d. If select automatic mode **2AUTO** (AUTO), screen returns to the setup menu with logging mode (see figure 3-1-7-2).



1. HAND hand
2. AUTO automatic

Figure 3-1-7-1: Select save mode



1. HOUR hour
2. INTL interval
3. LOG mode

Figure 3-1-7-2: Setup menu of save mode

Automatic mode includes hour record and interval record. The cursor points to the current mode.

As figure 3-1-7-2, the 3rd item could decide if the automatic mode is operated automatically after start-up.



【 0 】 : After start-up, it will not operate automatically; 【 1 】 : After start-up, it will operate automatically.

- e. If select **1. HOUR** (HOUR), it returns to the file menu. Then, a record is saved every hour.
- f. If select the **2. INTL** (INTERVAL), the screen enters into the interval interface. (The interval range: 1 second ~ 99 hours 99 minutes and 99 seconds). After setup, it returns to the record mode. Then, a record is saved at every interval.
- g. If select **3. FU_0** (RUN_0), screen displays **3. FU_0** (RUN_1). Item **3. FU_0** is short-term logging, item **3. FU_1** is long-term logging.

Remark: If long-term record mode is set, the electricital type and pressure unit cannot be changed.

3.1.8 Enter save-file status





The operation steps:

- a. Select **8SEL** and press  .
Under the manual mode: cursor points to saved file's serial number;
Under the automatic mode: cursor points to the previous file's serial number.
- b. Please return to the main interface by pressing  , then ADT672 enter into the save-file status.





3.1.9 Quit save-file status

Press  to quit.

3.2 Use manual mode







- (1) In the main interface, enter into the file menu by pressing .
- (2) Select the file's serial number(1~30) by using  , press  to confirm.
- (3) Select **4.5Et** (SET) to set file's attributes (optional).
- (4) Select **7.5AVE** to save and go to the next menu.
- (5) Select **1.HANd** (hand) manual mode. The screen returns to file menu.
- (6) Select **8.5EL** to enter the save function. If file is vacant, the cursor will point to the first record. Otherwise, the cursor points to the last record.
- (7) Press  once to save a record in the main interface. Meanwhile, the record in the right reading area will add 1 (1~40).

3.3 Use hour-record function

- (1) Press  to enter into the file menu in the main interface.
- (2) Select a file's serial number by using   and press . Under the record mode, the starting position always points to the previous. Example: The No.20 record of 10th file of last the entry is No.1 file of this time. After entering into the automatic mode, the next new position is 21st record of No.10 file.
- (3) If user initialize save position, select **5.A_DEL** to delete all data. The new position is No.1 record of No.1 file.
- (4) Select **4.5Et** to set the file's attributes (optional).
- (5) Select **7.5AVE** to save and go to the next menu.

- (6) Select **1 HOUR** hour record mode and the screen returns to the file menu.
- (7) Select **8SEL** to startup the save function. The cursor points to the previous saved position.
- (8) In the main interface, it saves a record each hour till all 40 records are saved. Then, it will automatically switch to the next file until all file's storage is full. After that, it will automatically switch to the file No.1 and continue saving.

3.4 Use interval-record function.

- (1) Enter into the file menu by pressing  in the main interface.
- (2) Select a file's serial number by using   and press . Under the record mode. The starting position always points to the previous. Example: The No.20 record of 10th file of the last entry is No.1 file of this time. After entering into the record mode, the next new position is 21st record of No.10 file.
- (3) Select **SA DEL** to delete all file's data and initialize the save position. The new position is 1st record of 1st file.
- (4) Select **4SET** to set the file's attributes (optional).
- (5) Select **7SAVE** to set the save mode and enter into the next menu.
- (6) Select **2 INTL** (interval record mode) to enter into the interval setup interface.
- (7) Time format is **Hour: Minute: Second** (Maximum: 99 hours and 59 minutes and 59 seconds; Minimum: 1 second). After time is set, please goes back to automatic mode by pressing  and goes back to the file menu option by pressing .
- (8) Select **8SEL** to startup the save mode. In the main interface, the save file's position keeps same as the previous.
- (9) In the main interface, it saves a record each hour till all 40 records are saved. Then, it will automatically switch to the next file till all file's storage is occupied. After that, it will switch to the file No.1 once again and continue the new saving.

3.5 Automatic logging with startup

Set the 3rd item in the record mode menu as **3. FU_0** and it goes to the automatic mode after the ADT672 is restarted.

The record status has following features:

- (1) Electrical type remains the same as the previous setting(5 digits to display).
- (2) Pressure measure displays 5 digits.
- (3) Pressure remains the same as the previous setting.

To quit this function:

- (1) Set record mode 3rd item **3. FU_0**.
- (2) Or, change save mode to manual mode.

HART communication function

4.0 Connect HART

Before using HART function, the user should know the following:

- (1) If the transmitter is HART and its current type.
- (2) If the transmitter is supplied by external power or 24V of the ADT672.
- (3) If the 250 Ω sampling resistance is supplied externally or by the ADT672 (The default is supplied by the ADT672).

HART type transmitter has three kinds of connection types (see figure 4-0). It is recommended to use the first type.

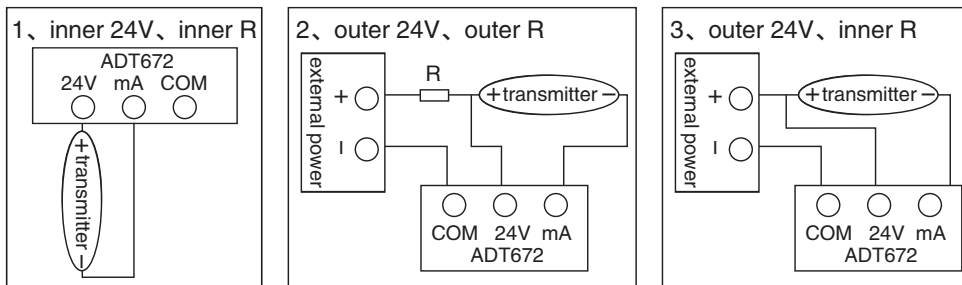

* 24V is HART+, mA is HART-

Figure 4-0: HART communication wiring diagram

4.1 Set inner/external sampling resistance

- (1) Select **9.9 1.7** (R_IN) in main menu.
- (2) As figure 4-1, screen displays the selection menu. (The default is inner resistance)
- (3) Press to select the suitable R resistance and return to the main menu.

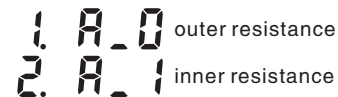

Figure 4-1: select sampling resistance

4.2 HART communication operation

The basic operation steps are:

- (1) Select the suitable wiring connection and connect the HART type transmitter.
- (2) Press to enter into the HART status and detect the transmitter.

(3) After the POLLING is successfully, please to choose HART functions.

(4) Finally, exit HART communication function by pressing .

4.3 Display status

Icon means the current status is HART communication;

Characters show the current HART's action or implementation.

4.4 Detective linkage

After select the suitable wiring connection, user must enter into the HART function via the POLLING address linkage.

As well as, user the following points below:

- (1) All HART transmitters must follow the POLLING detective instructions.
- (2) In general, the POLLING address default is "0" (or 1~15).
- (3) After the POLLING address is linked the next HART operation can be processed.

When pressing to link the transmitter there are the following status in HART area:

- (1) ,linking the"0" address.
- (2) ,linked the HART, user can process next step.
- (3) ,failed to link; however, user can press to detect the POLLING address from "1" to "15" again.

Suppose the address "8" is linked, the screen shows ; If all addresses fail, it returns to .

After the POLLING linked, user can select the nine HART functions by pressing .

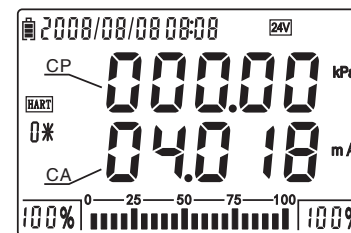

Figure 4-4: Linkage interface

4.5 HART function introduction

Before using these functions the user should know the following:

(1) Please refer the figure 4-5: HART transmitter working setup map

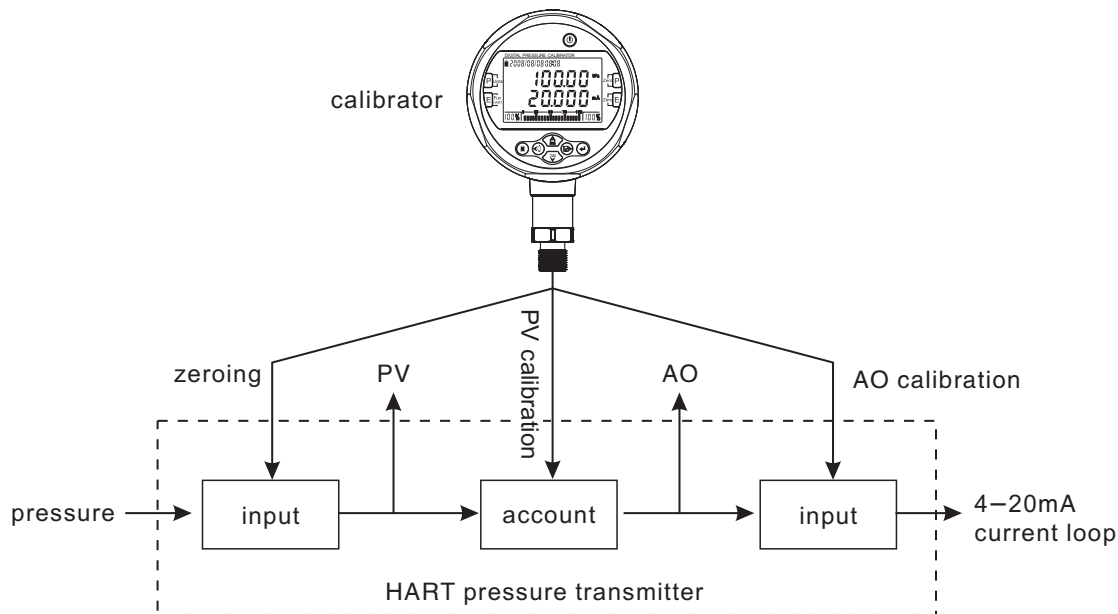

Figure 4-5: HART transmitter working setup map

(2) The abbreviated words of the ADT672:

PV (Primary variable): The pressure measured by HART transmitter

CP (Calibrator pressure): The pressure measured by calibrator ADT672.

AO (Analog output): The analog output current value set by HART transmitter.

CA (Calibrator amp): The current value measured by calibrator ADT672.

Sensor range: It is the rated pressure for the sensor in transmitter (Over pressure may cause damage).

PV range: The rated range in HART transmitter (Lower limit is corresponding to 4mA, higher limit is corresponding to 20mA).

Actual range: The actual range used in HART transmitter (Lower limit is corresponding to 4mA, higher limit is to 20mA).

(3) HART function's serial number is displaying in the status area, as \int | is function 1.

(4) As figure 4–5, HART pressure transmitter includes: PV calibration and AO calibration.

► **PV calibration:** The calibration is between PV and AO. Supply the pressure to transmitter. The max/min pressure is same as the higher/lower limit of transmitter. The actual pressure will have a linear relationship with the current range (4~20mA) of AO. The PV calibration has same function as the pushbutton [SPAN] & [ZERO] calibration in the transmitter.

► **AO calibration:** The calibration is between AO and CA (4~20mA). The transmitter outputs 4mA & 20mA, the CA value measured by calibrator is sent to the zero register and span register. Then, AO output value is approximating same as the CA measure value.

Example: The actual range of HART transmitter is 0~16kPa, current output is 4~20mA, 0.1%FS accuracy.

The every parameter changing like as following list:

Before calibration					
Supplied pressure	PV value	PV range	AO output	CA value	Maximum error
00.000 kPa	00.010 kPa	00.000 kPa	4.001 mA	4.024 mA	0.15%
16.000 kPa	16.020 kPa	16.000 kPa	20.020 mA	20.061 mA	0.38%

Calibration process					
Supplied pressure	PV value	PV range	AO output	CA value	Maximum error
00.000 kPa	00.010 kPa	00.010 kPa	4.024 mA	4.024 mA	0.15%
16.000 kPa	16.020 kPa	16.020 kPa	20.061 mA	20.061 mA	0.38%



Process 1: PV calibration



Process 2: AO calibration

After calibration					
Supplied pressure	PV value	PV range	AO output	CA value	Maximum error
00.000 kPa	00.010 kPa	00.010 kPa	4.000 mA	4.001 mA	0.006%
16.000 kPa	16.020 kPa	16.020 kPa	20.000mA	20.002mA	0.012%

From above lists, the transmitter is unqualified before calibration. However, it meets the accuracy requirements after calibration.

Remark: PV and AO calibrations are typical for HART instruments. However, AO instruction aren't always available for some transmitters.

For this situation, the ADT672 has a special calibration method to meet the calibration requirements.





(5) The ADT672 defined nine HART functions, as below:

F1: dISP_SEnSO _r (<i>DISPLAY_SENSOR</i>)	Display pressure range of the sensor in transmitter.
F2: dISP_rAngE (<i>DISPLAY_RANGE</i>)	Display transmitter's PV range, switch PV units, transfer PV range.
F3: dISP_dAP (<i>DISPLAY_DAMP</i>)	Display the transmitter's damp time, and adjust it.
F4: dISP_CP-PV (<i>DISPLAY_CP-PV</i>)	Display the calibrator's CP value and transmitter's PV value.
F5: dISP_CP-AO (<i>DISPLAY_CP-AO</i>)	Display the calibrator's CP value and transmitter's AO value
F6: dISP_CA-AO (<i>DISPLAY_CA-AO</i>)	Display calibrator's CA value and transmitter's AO value.
F7: LOOP_AO (<i>LOOP AO TEST</i>)	Fixed analog loop current output, AO calibration process(CALIB_AO).
F8: CALIB_PV (<i>CALIBRATE PV</i>)	PV calibration process.
F9: CALIB_SPEC (<i>CALIBRATE SPECIAL</i>)	A special calibration of ADT672, please refer 4.5.9.

4.5.1 Function 1: Display sensor range

► **Sensor range:** It is the rated pressure of the sensor in transmitter . Over pressure may damage the sensor.

The operation method is as follows:

- a. Switch to HART function 1 by pressing  , as figure 4-5-1-1.
- b. Display the sensor's range by pressing  , as figure 4-5-1-2.
- c. Press  to return to figure 4-5-1-1; switch to function 2 by pressing  .

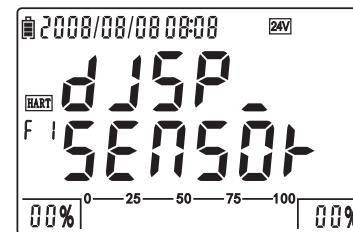

Figure 4-5-1-1: F1 entrance interface

4.5.2 Function 2: Display PV range, switch PV unit, transfer PV range

- ▶ **PV range:** the rated pressure range in transmitter, lower/higher limit is corresponding to the 4 mA and 20 mA respectively.
- ▶ **Switch PV unit:** mmH₂O, inH₂O, inHg, mmHg, kgf/cm², psi, kPa, MPa, Pa, mbar, bar.
- ▶ **Transfer PV range:** Change PV range (new PV range corresponds to the AO output).

The operation method as following:

- a. Switch to HART function 2 by pressing , as figure 4-5-2-1.
- b. As figure 4-5-2-2, press to show the PV range and it returns to the interface as figure 4-5-2-1 by pressing . Switch to function 3 by pressing .
- c. Press to switch the PV units.
- d. The steps of transfer range's lower limit:
 - ① Pressing once, the digit of lower limit will flash once.
 - ② Input the lower limit value, press to confirm.
 - ③ After the screen shows " _ _ _ _ _ " for 2 seconds, setup is finished.
- e. The steps of transfer range's higher limit:
 - ① Pressing once, the digit of higher limit will flash once.
 - ② Input the higher limit value, press to confirm.
 - ③ After the screen shows " _ _ _ _ _ " for 2 seconds, setup is finished.

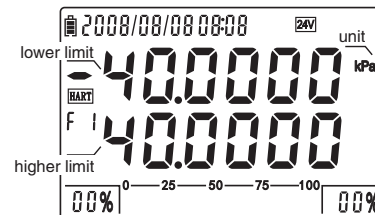

Figure 4-5-1-2: Sensor range

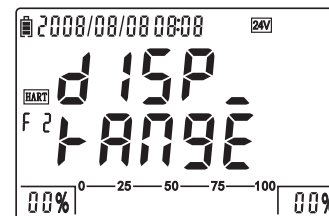

Figure 4-5-2-1: F2 entrance

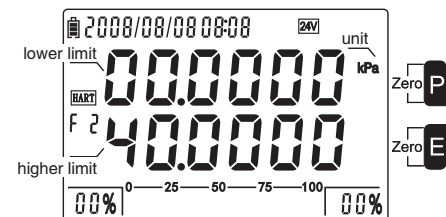

Figure 4-5-2-1: F2 entrance

4.5.3 Function 3: Display and adjust damp time

► **Damp time:** the stability time. An adjustment will may improve unstable performance.

(Damp time unit: second).

The operation method as following:

a. As figure 4-5-3-1, switch to HART function 3 by pressing .

b. As figure 4-5-3-2, press to show the transmitter's damp time. Press to return to the figure 4-5-3-1.

Switch to function 4 by pressing .

c. Press the direction keys to adjust the damp time. If the adjustment is successful, the screen displays" _ _ _ _ _ " for 2 seconds.

Otherwise, it will return to the interface as figure 4-5-3-1.

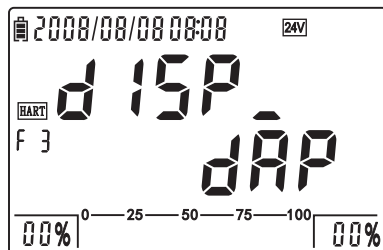

Figure 4-5-3-1: F3 entrance interface

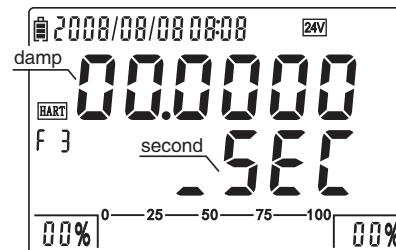

Figure 4-5-3-2: display damp time

4.5.4 Function 4: display CP value and PV value

The operation method as following:

- As figure 4-5-4-1, press to enter into HART function 4.
- As figure 4-5-4-2, press to display CP and PV value; The units remain the same as pressure units; Under this interface, press to go to figure 4-5-4-1; Press to go function 5.
- Press to switch CP & PV units. (mmH₂O, mmHg, inH₂O, inHg, psi, kPa, MPa, Pa, kgf/cm², mbar, bar)
- Press to clear the CP value and PV value to zero.

4.5.5 Function 5: display CP value and AO value

The operation method as following:

- Switch to HART function 5 by pressing , as figure 4-5-5-1.
- As figure 4-5-5-2, screen shows CP and AO value by pressing ; the digits of CP and AO are determined by pressure and current respectively. Under this interface, press to switch to the interface as figure 4-5-5-1; Press to function 6.
- Press to switch CP unit; Press to clear the CP value to zero.

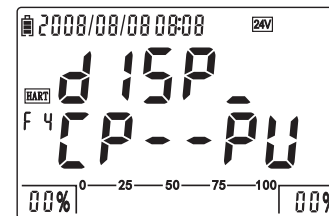

Figure 4-5-4-1: F4 entrance

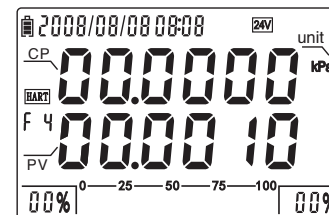

Figure 4-5-4-2: display CP value & PV

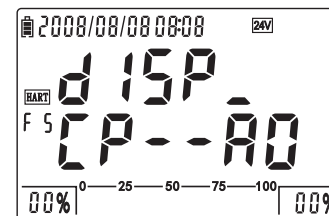

Figure 4-5-5-1: F5 entrance

4.5.6 Function 6: Display CA and AO value

Operation method:

- As figure 4-5-6-1, press to HART function 6.
- As figure 4-5-6-2, press to display CA value and AO value. (The units remain unchanged)
press to the interface as figure 4-5-6-1; Press to function 7.

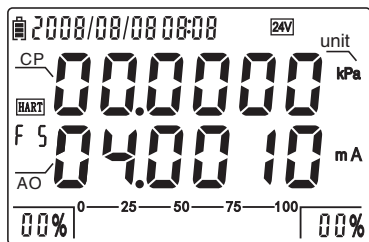

Figure 4-5-5-2: display CP & AO

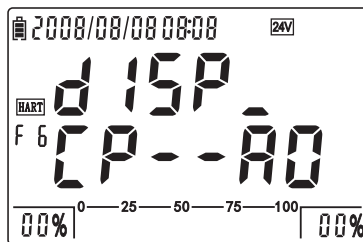

Figure 4-5-6-1: F6 entrance

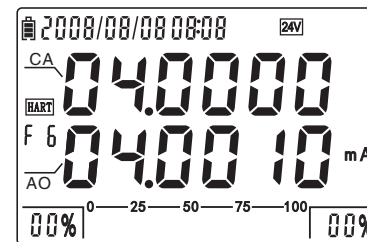

Figure 4-5-6-2: Display CA & AO

4.5.7 Function 7: Fixed loop analog current test, AO calibration

This test is to appoint to the fixed loop current analog output of AO value. The ADT672 can supply analog current of 4 mA, 12 mA and 20 mA. This function can be used to determine the accuracy of a transmitter's output current. If accuracy is unqualified, please start AO calibration as following:

(1) Switch to HART Function 7 by pressing , as figure 4-5-7-1.

(2) As figure 4-5-7-2, press to display the analog loop current.

Switch the points among 4 mA, 12 mA, 20 mA by using .

Under this interface, press to the interface as figure 4-5-7-1,

press to function 8.

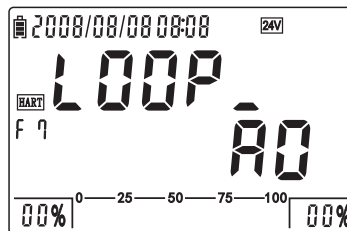
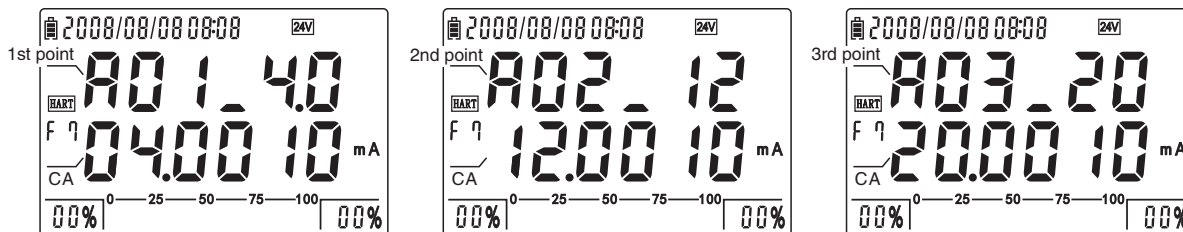

Figure 4-5-7-1: F7 Entrance



Picture 4-5-7-2: Fixed loop current output

(3) To recalibrate, proceed as below:

a. Under the interface of figure 4-5-7-2, enter into AO calibration by pressing (As picture 4-5-7-3).

b. By using to select the sequence of 4mA calibration or 20mA calibration. After The CA value is steady, press

to finish the calibration. Once every point is calibrated, the first line shows the character [END] (as figure 4-5-7-4).

c. After calibration, press to go to the figure 4-5-7-1.

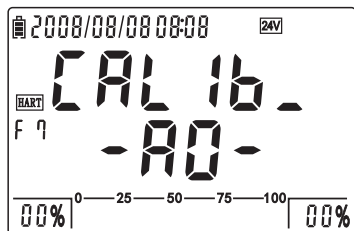

Figure 4-5-7-3: AO calibration entrance

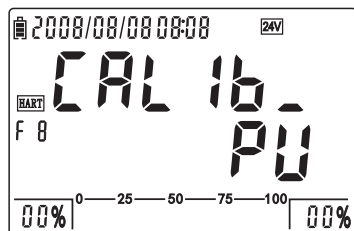

Figure 4-5-8-1: F8 entrance

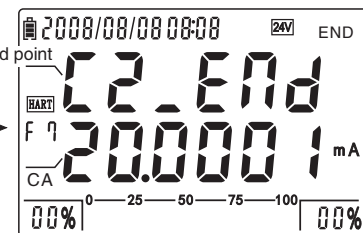
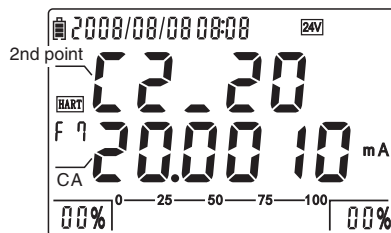
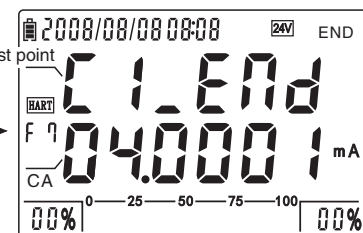
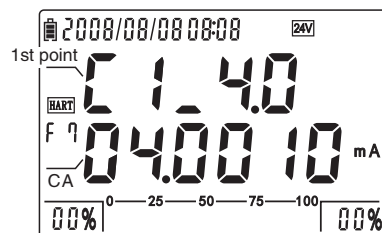

Figure 4-5-7-4: AO calibration process

4.5.8 Function 8: PV calibration process

The operation method:

a. Switch to HART Function 8 by pressing , as figure 4-5-8-1.

b. Press to enter into the calibration menu. Calibration includes lower limit point and higher limit point. Use

to prioritize the calibration points. Then supply the pressure to the selected point. After CA value is steady, press to finish the calibration. Once every point is calibrated, the first line shows the character [END], the second line displays the new lower/higher limit of PV range. (As figure 4-5-8-2)

c. After calibration, press to the interface as figure 4-5-8-1, press to function 9.

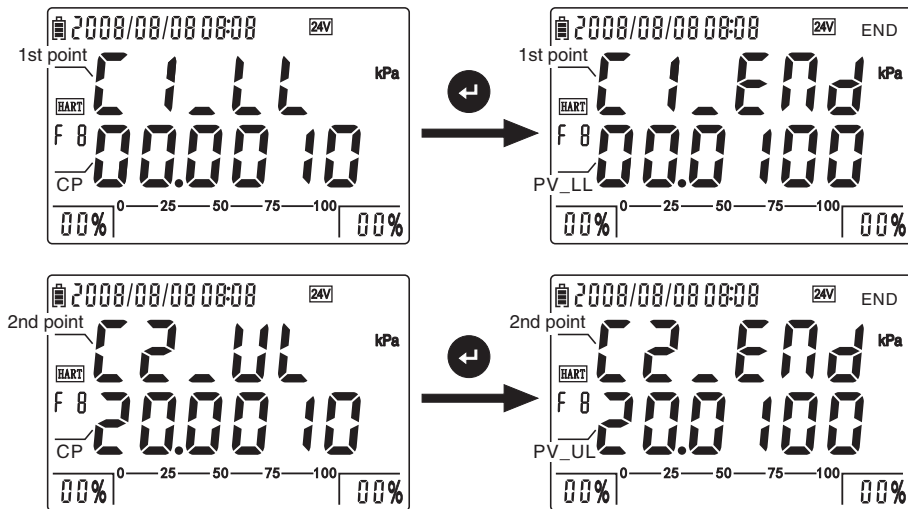





Figure 4-5-8-2: PV calibration process

4.5.9 Function 9: Special calibration function

For some transmitters, AO calibration instructions cannot be supported. For this situation, ADT672 has a special calibration method to resolve it. After calibration, the actual pressure range has the linearity relationship with current loop CA (4~20) mA. This is very useful in application of transmitter with (4~20) mA loop current.

Operation steps as below:

- As figure 4-5-9-1, press  to enter HART function 9; press  to enter the detective linkage (see figure 4-4).
- As figure 4-5-9-2, press  to entry calibration menu. The ADT672 self-selects the higher limit point or lower limit point according to the different pressure supplied by users. After the CP and CA is steady, press  to make screen shows " _ _ _ _ _ " in second line. This means the current calibration is finished. If this result is not ideal, it could be re-calibrated.

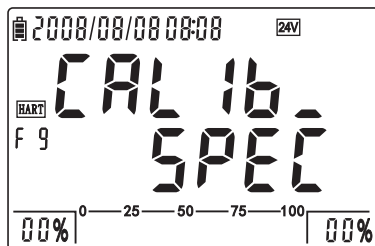

Figure 4-5-9-1: F9 entrance

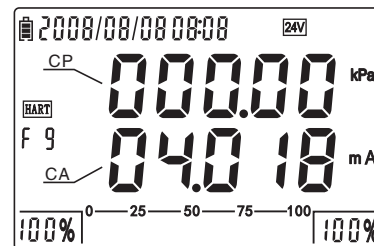

Figure 4-5-9-2: Special calibration interface

Calibration function

5.0 Introduction

This function is recalibrate the ADT672. First allow a warm up time of 30 minutes. The ADT 672 should be run on battery power. Exercise the gauge three times. Now, please start the calibration process. If the ADT672 is in irregular working status, please use default setting function.

Remark: The calibration must be met the required conditions.

5.1 Calibration condition

(1) Environment:

Temperature: 20°C 2 °C; Relative humidity: (45–75) %;

Atmosphere pressure: (86–106) kPa; Power: recommend battery.

(2) Equipments:

Standard voltage source, standard current source, standard pressure source.

5.2 Calibration menu's operation and content

Please refer the [1.6 menu introduction].

5.3 Pressure calibration

Please read the following:

(1) Calibration points will depend on the ADT762 pressure range.

- a. Single pressure range: Two calibration points are required. Example: the calibration default point for (0~2)MPa, is 0 MPa and 2 MPa; the default points for (–100~0)kPa is –100 kPa and 0 kPa. The calibration point for –100 kPa may be

may be unattainable. In this case the low pressure calibration point would be as low as possible.

b. Dual pressure range: Three calibration points are required. Example: (-20~20)MPa, the default pressure is -20 kPa, 0 kPa and 20 kPa.

(2) The calibration points are as below:

a. 2-point calibration: 1st point is lower limit, 2nd point is higher limit.



Example: (0 ~ 100)kPa: 1st point: 0kPa, 2nd point: 100kPa; (-100 ~ 0)kPa: 1st point: -100kPa, 2nd point: 0kPa.





b. 3-point calibration: 1st point is lower limit, 2nd is 0, 3rd point is higher limit.

Example: (-20 ~ 20)kPa: 1st point: -20kPa, 2nd point: 0kPa, 3rd point: 20kPa.

(3) During calibration, user can choose the prioritized points. However, it is suggested to use default setting.

Example: ADT672 w/ (0~2) MPa

(1) Press  to enter into passport menu, input the password "2003" and press  to enter into calibration menu.

(2) Select **IP_CAL** and press  to enter into the entrance interface. The **[01]** of left reading area is 1st calibration point, the user can select points by using  . Please press  to start calibration. (as figure 5-3-1)

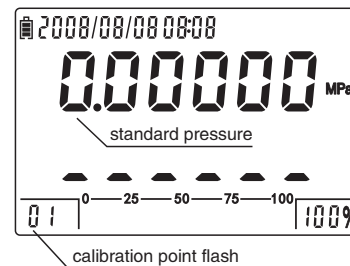





Figure 5-3-1: 1st point entrance

- (3) The first line flashes to remind the user to input the standard pressure of 1st point. (In this example, it is 0.00000 MPa)
- (4) As figure 5-3-2, screen displays the interface of 1st calibration point. Please supply 0.00000 MPa pressure, and press  to finish the 1st point calibration after it is stable. As figure 5-3-3, switch to the 2nd point calibration interface.
- (5) Under the interface of 2nd calibration point, the first line flashes for new standard pressure. In general, it is the default (In this example, it is 2.00000 MPa), press  for next step.
- (6) As figure 5-3-4, screen displays the 2nd point calibration interface. Please supply 2.00000 MPa pressure and press  to finish the 2nd point calibration after it is stable. The screen switches to the interface as figure 5-3-1 and the calibration is finished.
- (7) Press  to return to the calibration function menu. The calibration is effective if **2P_0** changed to **2P_1**.

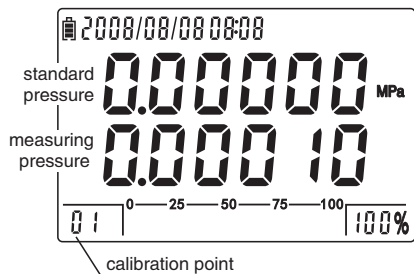

Figure 5-3-2: 1st point calibration

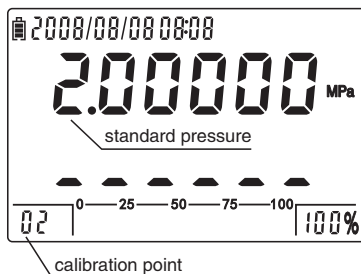

Figure 5-3-3: 2nd point entrance

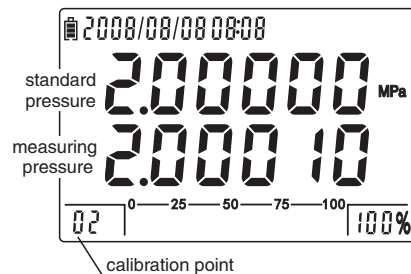



Figure 5-3-4: 2nd calibration

5.4 Cancel pressure calibration

(1) Enter into the calibration menu

(2) Select **2P_1** and press  , the calibration is canceled if screen displays **2P_0** .

5.5 Current calibration

It is same as the pressure calibration. The default 3–points calibration points are:

① First points: –30mA; ② Second point: 0 mA; ③ Third point: 30mA.

Please note the standard calibration point can be adjusted. The current calibration menu is **3.1.CAL** .

5.6 Cancel current calibration

(1) Enter into the calibration menu

(2) Select **4.1_1** and press  , the calibration is canceled if screen displays **4.1_0** .

5.7 Voltage calibration

It is same as the current calibration. The default 3–points calibration points are:

① First points: –30V; ② Second point: 0 V; ③ Third point: 30V.

Please note the standard calibration point can be adjusted. The voltage calibration menu is **5V.CAL** .

5.8 Cancel voltage calibration

(1) Enter into the calibration menu;

(2) Select **6V_1** and press  , the calibration is canceled if screen displays **6V_0** .

5.9 Cancel previous pressure zeroing

(1) Enter into the calibration menu;

(2) Select **7.2E+0** and press  .

6.0 Accessories

- | | |
|---------------------------------------|-------|
| (1) Test cable: Model number 9021 | 1 set |
| (2) Warranty | 1 pc |
| (3) User's Manual | 1 pc |
| (4) Adapter: Model number 9814 | 1 pc |
| (5) Li-ion Battery: Model number 9702 | 1 pc |

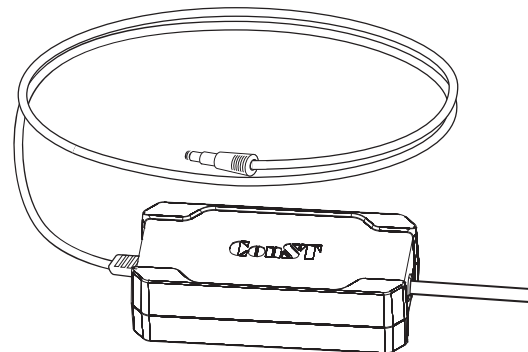
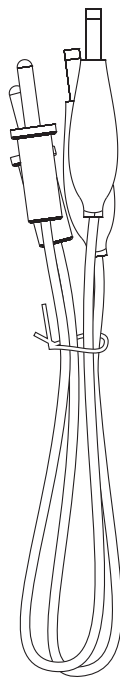

Appendix I: Typical application of ADT672

(1) Pressure gauge calibration

The operation steps are:

- ① Connect the pressure gauge and ADT672 on the pressure pump.
- ② According to verification regulation, make ADT672 as a reference gauge to verify (calibrate) the pressure gauge.



(2) Pressure switch calibration



Operation steps are:

- ① Connect the pressure switch and ADT672.
- ② Press  to select pressure switch measure. (optional: please select the triggering type in the menu for pressure triggering measure)
- ③ According to sketup map, please connect the test in terminals cables.
 - SW connect "+" of switch, red color;
 - COM connect "-" of switch, black color.
- ④ Follow all verification regulations, take ADT672 as a reference gauge to calibrate (verify) the pressure switch.



(3) Pressure transmitter calibration

Operation steps as following:

- ① Connect the pressure transmitter and ADT672 on the pressure test pump.
- ② Pressing  to select the current measure item, and press  to start 24V output. If user needs to control the output time, please find the related option in the menu.
- ③ As right figure, connect the pressure transmitter and ADT672.
 - 24V connect the transmitter +, red color.
 - mA connect the transmitter.
- ④ Following all verification regulations, take ADT672 as a reference gauge to calibrate (verify) the pressure transmitter.



Remark: If user wants to calibrate the HART type pressure transmitter, please enter into the HART status by pressing .

Please refer the [HART communication function introduction] for further information.

Appendix II: Communication protocol

(1) Instruction format

① Data sending format:

A: X: Knnnn: C0: C1: C2: C3: C4+EOS (end of symbol)

A: 1 byte, the instrument's communication address

X: 1 byte, only for W (write) or R (read)

K: 1 byte, M (measure), F (File), O (others)

nxxx: 2–5 bytes, the items operated by K instruction

C0: C1: C2: C3: C4: Parameter, please refer the specified instruction introduction

Eos: 0x0 (hex)

② Data returning format:

A: X: Knnnn: C0: C1: C2: C3: C4+ Eos, hereinto:

A: Instrument communication address

X: E or F, E is error info of this frame dates, F is feedback info

Knnnn: It is same as the instruction from upper machine

C0: C1: C2: C3: C4: Feedback data or error info

Eos: 0x0(hex)

③ The communication setting of serial port

A(address): the range is 1 ~ 112, factory default setting is 1

Baud rate: 1200、2400、4800 and 9600 is selected, the factory default setting is 9600

Data bit length: 8 bits

Stop bit: 2 bits

Parity digit: N/A

Data flow control: N/A

(2) Instruction details

Instructions									Function Introduction	Correct return value	
A	X	Knnnn	C0	C1	C2	C3	C4	Eos			
Address	R	OVER	-	-	-	-	-	-	0X00	Read software version No.	A:F:OVER:version No.+ Eos
	R	OTYPE	-	-	-	-	-	-		Read instrument Mode No.	A:F:OVOK:Mode No. +Eos
	R	OCODE	-	-	-	-	-	-		Read serial number	A:F:OCODE:serial No. OK+ Eos
	R	OPRDA	-	-	-	-	-	-		Read production date	A:F:OPRDA:production date OK+ Eos
	W	OBLAC	0 (close) 1 (open)	-	-	-	-	-		Open/close backlight	A:F:OBLAC:OK+ Eos
	W	OBEEP	0 (close) 1 (open)	-	-	-	-	-		Open/close buzzer	A:F:OBEEP:OK+ Eos
	W	OKEY	0 (close) 1 (open)	-	-	-	-	-		Open/close keypad	A:F:OKEY:OK+ Eos
	R	OTIME	-	-	-	-	-	-		Read clock's time	A:F:OTIME: H: M: S: +Eos
	W	OTIME	hour	minute	second	-	-	-		Set up clock's date	A:F:OTIME:OK+ Eos
	R	ODATE	-	-	-	-	-	-		Read clock's date	A:F:ODATE:Y:M:D+ Eos
	W	ODATE	year	month	day	-	-	-		Write clock's date	A:F:ODATE:OK+ Eos
	R	OBATV	-	-	-	-	-	-		Read battery's total voltage	A:F:OBATV:total voltage +Eos
	R	EXMENU	-	-	-	-	-	-		Read menu status (0:N/A; 1:Available)	A:F:EXMENU:menu status +Eos
	W	EXMENU	-	-	-	-	-	-		Quit menu status	A:F:EXMENU:OK +Eos
	R	OADDR	-	-	-	-	-	-		Read series port's add(1-121)	A:F:OADDR:address +Eos
	W	OADDR	address	-	-	-	-	-		Set series port's add(1-121)	A:F:OADDR:OK +Eos
	W	OBAUD	Baud rate	-	-	-	-	-		1200, 2400, 4800, 9600	A:F:OBAUD:OK +Eos
	W	O24V	0 (close) 1 (open)	-	-	-	-	-		Open/close 24V output	A:F:O24V:OK +Eos
W	O24VT	1 (10minute) 2 (30minute) 3 (60 minute) 4 (full-open)	-	-	-	-	-	Set up working time of 24V	A:F:O24V:OK +Eos		

Instructions									Function Introduction	Correct return value	
A	X	Knnnn	C0	C1	C2	C3	C4	Eos			
Address	W	OBIT	P (pressure) E (electricity) A (all)	0 (5 digits) 1 (6 digits)	-	-	-			Switch the display resolution	A:F:OBIT:OK +Eos
	W	OCONT	0 (close) 1 (open)	-	-	-	-			Set data sending continuously	A:F:OCONT:OK +Eos
	R	ORAN	-	-	-	-	-			Read pressure range and type (0: gauge or absolute, 1: differential)	A:F:ORAN:lower limit: high limit: pressure unit +Eos
	R	MRMD	-	-	-	-	-			Read current pressure value.	A:F:MRMD:P value: unit +Eos
	R	OUINF	-	-	-	-	-			Read the selected pressure unit info code, refer to App.(5)	A:F:OUINF:unit info code +Eos
	W	OUNIT	Shortening Unit	-	-	-	-			Switch pressure unit, refer App. 4	A:F:OUNIT:OK +Eos
	W	OZERO	-	-	-	-	-			Pressure to zero	A:F:OZERO:OK +Eos
	W	MZERO	P (Pressure) I (Current) V (Voltage)	-	-	-	-		0X00	Cancel the previous zeroing	A:F:MZERO:OK +Eos
	R	OPEAK	-	-	-	-	-			Read peak pressure	A:F:OPEAK:High peak value:Lower peak value :unit + Eos
	W	OPKZE	-	-	-	-	-			Clear peak pressure to present value.	A:F:OPKZE:OK +Eos
	W	MRATE	0(low speed) 1(high speed)	-	-	-	-			Adjust pressures responsetime	A:F:MRATE:OK +Eos
	W	MCONE	I (current) V (voltage) T (temperature) S (switch) L (count-down) H (HART)	-	-	-	-			Switch measure items	A:F:MCONE:OK +Eos

Instructions									Function Introduction	Correct return value	
A	X	Knnnn	C0	C1	C2	C3	C4	Eos			
Address	R	MVAL	-	-	-	-	-	-	0X00	Read measuring electricity date	Current, voltage, temperature A:F:MVAL:value: mA /V/°C+Eos Switch A:F:MVAL:ON/OFF:SW +Eos Count down A:F:MVAL:START: Start pressure: END:final pressure: hour: minute: second +Eos Return HART function, please refer (8)
	W	OVALZ	-	-	-	-	-	-		Electricity zeroing is only effective for I & V	A:F:OVALZ:OK +Eos
	R	OTEMP	-	-	-	-	-	-		Read environment TEMP.	A:F:OTEMP:temperature: °C+Eos
	W	MSWI	0 (no trigger) 1 (off→on) 2 (on→off) 3(off→on→off) 4(on→off→on)	-	-	-	-	-		Set up pressure switch's working type.	A:F:MSWI: OK +Eos
	W	MSTIO	-	-	-	-	-	-		Unlock the trigger switch	A:F:MSTIO:OK +Eos
	R	RSWI	-	-	-	-	-	-		Read switch's trigger value	A:F:RSWI:pressure value: unit: switch on/off status: trigger symbol +Eos
	W	MLEKT	hour	minute	second	-	-	-		Set up leak hunting time	A:F:MLEKT:OK +Eos
	W	HARTSW	0-8 HART function	-	-	-	-	-		Switch HART function item 0-8	A:F:HARTSW:OK +Eos
	W	FIXAO	4-20mA current value	-	-	-	-	-		Set transmitter outputting the fixed current. It is canceled if current is 0.	A:F:FIXAO:OK +Eos
	W	AOCAIB	0 (4mA) 1 (20mA)	Current calibration	-	-	-	-		Calibrate the transmitter's loop current	A:F:AOCAIB:OK +Eos
	W	PVCAIB	0 (ZERO) 1 (SPAN)	-	-	-	-	-		Calibrate the high and lower limit of transmitter	A:F:PVCAIB:OK +Eos
	W	PVTRAN	High limit	Lower limit	Unit	-	-	-		Transfer transmitter range	A:F:PVTRAN:OK +Eos
	W	DAMPING	Damp value	-	-	-	-	-		Set transmitter damp value	A:F:DAMPING:OK +Eos
	R	HARTSTA	-	-	-	-	-	-		Read HART order implement status	A:F:HARTSTA:Status (0/1) +Eos

Instructions									Function Introduction	Correct return value	
A	X	Knnnn	C0	C1	C2	C3	C4	Eos			
Address	W	HARTCMD	HART sending frame	-	-	-	-	-	0X00	Set up HART' s command in random	HART return frame
	W	FMODE	0(manual) 1(auto)	0(hour) 1(interval)	0(short) 1(long)	-	-	Set up file storage mode		A:F:FMODE: OK +Eos	
	R	FMODE	-	-	-	-	-	Read save mode		A:F:FMODE: manual/automatic: hour : interval: interval time: file (Y/N) +Eos	
	W	FTIME	hour	minute	second	-	-	Set the time of hour-record		A:F:FTIME:OK +Eos	
	W	FSTART	1 ~ 30	-	-	-	-	Appoint a file and enter save status		A:F:FSTART:OK +Eos	
	W	FSAVE	-	-	-	-	-	Save a new record		A:F:FSAVE:OK +Eos	
	W	FSTOP	-	-	-	-	-	Quit save status		A:F:FSTOP:OK +Eos	
	R	FRDO	File number	-	-	-	-	Read a file's data		Return format refer to (1)	
	W	FDELO	File number	-	-	-	-	Delete a file		A:F:FDELA:OK +Eos	
	W	FDELA	-	-	-	-	-	Delete all files		A:F:FDELA:OK +Eos	
	W	OCPS	-	-	-	-	-	Entrance instruction of pressure calibration		A:F:OCPS:OK +Eos	
	W	OCP	Z(zero) M(middle) F(full)	Standard P at calibration point	-	-	-	Input the pressure value and relative calibration point, for calibration		A:F:OCP:OK +Eos	
	W	OCPOK	1(save)0(cancel)	-	-	-	-	Quit pressure calibration		A:F:OCPOK:OK +Eos	
	W	OCIS	-	-	-	-	-	Entrance instruction for current calibration		A:F:OCIS:OK +Eos	
	W	OCI	1/ 2 /3	Standard I at calibration point	-	-	-	Input the current value and relative calibration point, for calibration		A:F:OCI:OK +Eos	
	W	OCIOK	1(save)0(cancel)	-	-	-	-	Quit current calibration		A:F:OCIOK:OK +Eos	
	W	OCVS	-	-	-	-	-	Entrance instruction for voltage calibration		A:F:OCVS:OK +Eos	
	W	OCV	1/ 2 /3	Standard V at calibration point	-	-	-	Input the voltage value and relative calibration point, for calibration		A:F:OCV:OK +Eos	
	W	OCVOK	1(save)0(cancel)	-	-	-	-	Quit voltage calibration		A:F:OCVOK:OK +Eos	
	W	OFALT	P / I / V	-	-	-	-	Cancel calibration parameter and calculation for P / I / V, go back to factory default setting.		A:F:OFALT:OK +Eos	
W	OTAG	Note No.(1 - 10)	Note content 50 bytes longest	-	-	-	Write note's information	A:F:OTAG:OK +Eos			
R	OTAG	Note No.(1 - 10)	-	-	-	-	Read note's information	A:F:OTAG:Note #:Note info +Eos			

(3) The file's transfer format

```

Filename: F01          /* File name */
Number: 111111        /* the serial No. of second gauge */
Minscale: 001.000    /* Minimum scale value */
Datesum: 01          /* the saved points in file */
No.01 06/07/03 10:29:53 /* Point number, save date, time */
0.0108MPA            /* Pressure measure value */
-0.0000mA           /* Electricity measure value */

```

(4) Pressure units shortening list

Shortening	H ₂ O	HG	PSI	MBAR	BAR	PA	KPA	MPA
Standard	mmH ₂ O	mmHg	psi	mbar	bar	Pa	kPa	MPa

(5) Pressure units info code

Info code use 1 byte. 1: this pressure unit is available; 0: N/A

HG	H ₂ O	PSI	BAR	MBAR	MPA	KPA	PA
MSB							LSB

(6) The format of automatically data sending

The format length is 32 bytes, and add the Eos 0x0 at the end.

```

Example: *P 0.0364 MPA *I -0.0001 mA
          *P 0.0367 MPA *V -0.0158 V
          *P 0.0374 MPA *T 32.19 °C
          *P 0.0375 MPA *S 000000.0 0
          *P 0.0397 MPA *L 10:00:05

```

(7) Wrong sequence number explanation

- 1000 Accept outflow from buffer.
- 1001 The instruction is being protected now.
- 1004 Digital character string have non-permitted characters.
- 1005 Pressure unit is irregular.
- 1007 Parameter is wrong.
- 1016 The data can't meet the zeroing requirements.
- 1017 The parameter quantities is not enough.
- 1018 Unsupported instruction.
- 1019 The format of operation password is wrong.
- 1020 r/w Symbol is wrong.
- 1021 The file number is out of range.
- 1023 The shortening pressure unit is wrong.
- 1024 This pressure unit can't use.
- 1025 The series address is out of range 1-112.
- 1026 Baud rate is wrong.
- 1027 The time parameter of 24V open/close is wrong.
- 1029 Parameter is too long.
- 1030 Not contact with HART yet.

(8) HART function's return format

► **Function 0:** Linked the POLLING successfully

Address: F: MVAL: DEVICE: Manufacture: Equipment type: Equipment ID

Example: 001: F: MVAL: DEVICE: Endress & Hauser: Cerabar M: W ["Q

► **Function 1:** Display the sensor ranges used by HART transmitter.

Address: F: MVAL: SENSOR_RANGE: Lower limit of sensor: Higher limit of sensor: Pressure unit

Switch to function 1, it is returned but not enter into the interface yet (example 1); oppositely, it returns after interface displayed (example 2)

Example 1: 001: F: MVAL: SENSOR_RANGE: 0.00000000: 0.00000000: NC

Example 2: 001: F: MVAL: SENSOR_RANGE: -40.00000000: 40.00000000: KPA

► **Function 2:** Display and transfer the PV range of transmitter, switch PV units

Address: F: MVAL: PV_RANGE: Lower limit of PV range: Higher limit of PV range: Pressure unit

Switch to function 2, it returned but not enter in the PV interface yet (example 1); oppositely, it returns after interface displayed (example 2)

Example-----001: F: MVAL: PV_RANGE: 0.00000000: 0.00000000: NC

Example-----001: F: MVAL: PV_RANGE: -0.01506382: -0.02472788: KPA

► **Function 3:** Display and adjust transmitter's damp value

Address: F: MVAL: DAMPING: damp value: Unit (second)

Example-----001: F: MVAL: DAMPING: 1.000: s

► **Function 4:** Simultaneously display the pressure value measured by calibrator and transmitter.

Address: F: MVAL: PV/MP_VALUE: pressure measured by transmitter:Unit:pressure measured by calibrator:Unit

Switch to function 4, it returned but not enter in the PV/MP interface (example 1); oppositely, it returns after interface displayed (example 2)

Example 1-----001: F: MVAL: PV/MP_VALUE: 0.00000: NC: 0.01414: KPA

Example 2-----001: F: MVAL: PV/MP_VALUE: 0.00973: KPA: 0.00984: KPA

-
- ▶ **Function 5:** Simultaneously display the pressure value measured by calibrator and the current value measured by transmitter
Address:F:MVAL:AO/MP_VALUE:Current value measured by transmitter:Unit:pressure value measured by calibrator:Unit
Switch to function 5, it returned but not enter in the AO/MP interface yet (example 1); oppositely, it returns after interface displayed (example 2)
Example 1-----001: F: MVAL: AO/MP_VALUE: 0.00000: MA: 0.01088: KPA
Example 1-----001: F: MVAL: AO/MP_VALUE: 4.00000: MA: 0.01012: KPA
 - ▶ **Function 6:** Simultaneously display the both current value measured by calibrator and transmitter.
Address: F: MVAL: AO/MI_VALUE:Current value measured by transmitter:unit:current value measured by calibrator:unit
Example: 001: F: MVAL: AO/MI_VALUE: 4.00000: MA 4.00265: MA
 - ▶ **Function 7:** Appoint to the fixed current output from transmitter; calibrate the current output from transmitter
Address: F: MVAL: FIXAO/MI_VALUE: Current output from transmitter: unit: current value measured by calibrator: unit
Switch to function 7, it returned but not enter in the FIXAO/MI_VALUE yet (example 1); oppositely, it returns after it is displayed (example 2)
Example1: 001: F: MVAL: FIXAO/MI_VALUE: 0.00000: MA 4.00255: MA
Example2: 001: F: MVAL: FIXAO/MI_VALUE: 4.00000: MA 4.00249: MA
 - ▶ **Function 8:** Calibrate the PV ranges of transmitter
Address: F: MVAL: MP_VALUE: The pressure value measured by calibrator: unit
Example: 001: F: MVAL: MP_VALUE: 0.01025: KPA
 - ▶ **Function 9:** Special calibration mode
Address: F: MVAL: MP/MI_VALUE: Pressure value measured by calibrator: current value measured by calibrator: unit
Example: 001: F: MVAL: MP/MI_VALUE: 0.00346: KPA: 4.00242: MA



Additel Corporation

22865 Savi Ranch Parkway Ste F

Yorba Linda, CA 92887, USA

Phone: 714-998-6899

Fax: 714-998-6999

Email: service@additel.com

website: www.additel.com